

Cavity wall & Ceiling Installation guide for Amina Edge Invisible loudspeakers

Using BackboxCV345 for Edge5*i* and Edge7*i*

Using BackboxCV300 for Edge3

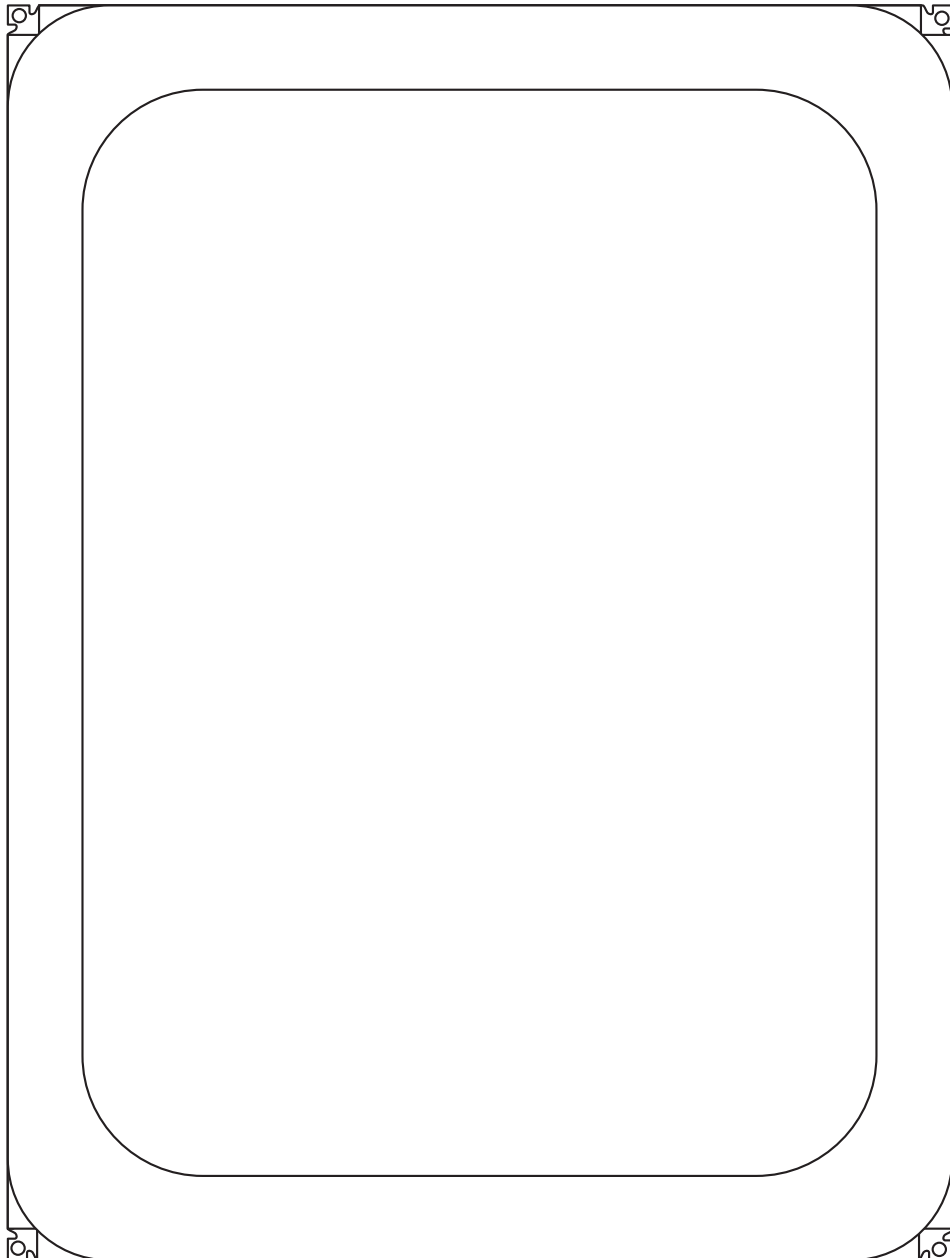

Amina Edge*i* Fully Concealed Loudspeakers

The Amina Edge*i* series of Loudspeakers are designed to deliver best in class audio performance in fully concealed in-wall and in-ceiling applications, preserving the interior aesthetic of any space.

Featuring a unique tapered perimeter, Amina Edge products are designed specifically for installation using a dry-wall / dry lining edge fill approach. The perimeter of the product is taped and joined. The front surface of the speaker is then decorated with paint, wallpaper or fabric.

What's in the box

The following items are included with each Amina Edge loudspeaker -

- 1 x Amina Edge loudspeaker
- 1 x installation template/quick reference installation guide
- 4 x Flange head fixing screws
- 1 x set 1mm shims
- 1 x set 2mm shims

Contents

Caution: Read before installing this product	3	Testing	26
Environmental.....	5	Testing the speaker.....	26
Sound in your Home:.....	6	Resistance test	26
Sound in your Work or Leisure Environment:.....	6	Connect the APU protection device	26
Message from the Managing Director	7	Sweep test.....	26
About the Manufacturer	7	Music test	26
Introduction	8	Problems during test.....	26
Installation options.....	8	Problems during test	27
Unpacking	8	Insecure drywall	27
Packaging	8	Metal studs	27
Compatibility	8	Cable buzzing	27
Overview	9	Lighting fixtures.....	27
Setup tips.....	10	Finishing	28
Installation.....	12	Filling the perimeter.....	28
Mounting accessories.....	12	Taping the joints.....	28
Speaker protectors.....	13	Feathering the panel edge.....	29
Speaker protectors.....	14	Fine surface finishing (optional)	30
Fixing method for BackboxCV	15	Decorating.....	31
Shims	19	Maintenance and cleaning	31
Fixing shims to the speaker	19	Re-decoration	31
Fixing shims to the BackboxCV.....	19	Fire resisting installation.....	32
Alignment and preparation	20	Pre-installation checks.....	33
Drywall / Dry line	20	Installation	34
Alignment required for plastering	20	Other fire resisting installation methods	40
Shim sizes.....	20	Accessories.....	41
New plasterboard walls (yet to be plastered)	21	Subwoofers.....	41
Pre-plaster the walls.....	21	Troubleshooting.....	42
Retrofit / pre-skimmed plasterboard..	22	Advice for testing	42
Retrofit alignment options.....	22	No or low sound output.....	42
Flush with surround.....	22	Distortion, buzzing or rattles at modest volumes.....	43
Flush with centre	22	Very low output after speaker passes electrical tests.....	43
Retrofit / pre-skimmed plasterboard (Flush with surround)	23	Distortion at higher volume levels.....	43
Alignment required for plastering	23	Specifications	44
Shim sizes.....	23	Warranty information.....	45
Retrofit / pre-skimmed plasterboard (Flush with centre)	24	Copyright information	45
Alignment required for plastering	24	Contact information.....	45
Shim sizes.....	24		

Caution: Read before installing this product

This manual contains detailed instructions required to install your Amina Edge Invisible Loudspeaker into a cavity wall using a BackboxCV housing or simple mounting blocks.



CAUTION:

The installation guide included with a BackboxCV describes the different installation steps required for other models of Amina Invisible loudspeakers. Refer only to the Installation steps in this guide when installing an Edge loudspeaker.



WARNING:

No attempt should be made to install a BackboxCV within existing building structures unless you are certain that no electric cables, water pipes, gas pipes or supporting joists will be cut through.

FIRE PROTECTION:

When making an intrusion into an internal wall or ceiling to install an Amina loudspeaker be sure to check the appropriate regulations pertaining to the required fire rating. Depending on the location of the intrusion and the applicable regulations it may be necessary to build in or install additional fire rated components or products to surround the speaker and back box. Amina Technologies take no responsibility for the correct specification and installation of any such fire protection system that is required behind their loudspeakers.

FIRE RESISTING INSTALLATION:

NOTE: Where building regulations state that an installation must comply with fire resisting standard BS476 Pt. 21: Timber floors, refer only to the instructions in the Fire Resisting Installation section on pages 31-38.



METAL FRAME CEILINGS:

When installing in metal frame (MF) ceilings (& walls), please ensure the assembled metal frame is fully solid and secure and that all metal mating joints are mechanically fixed or bonded together. Metal joints that are not tightly fixed have the potential to generate spurious buzzing noises as the two free edges rub against each other when activated by the acoustic energy generated by the Amina Loudspeaker. All debris, loose screws, excess materials etc, should be removed from above the ceiling to avoid unwanted rattles.



CLEANLINESS DURING INSTALLATION:

Always install the speaker when the general environment is clean and dust free. Keep each speaker protected in its shipping carton until cutting work is complete and the installation room has been cleaned down thoroughly. Never expose the rear of the loudspeaker to an environment containing airborne metallic particles and dust, as these will be attracted to the speaker's high power magnet causing damage to the loudspeaker.

Caution: Read before installing this product



SPEAKER PROTECTION:

Amina loudspeakers should be installed with an APU or other suitable electrical overload protection device. These devices help ensure the loudspeaker operates reliably for many, many years ahead, by limiting and protecting against temporary excessive audio signals that could damage the product.

Common sense should always prevail though. Your product should never be operated at repeated or consistently excessive audio levels. Never operate your Amina speakers at a level where audio reproduction appears distorted.

For the ultimate in protection, Amina recommend using the Amina A100Q digital amplifier to drive your loudspeakers. It prevents unwanted and excessive electrical energy from reaching the speaker whilst allowing it to perform at its very best at all times.

Please read carefully before installing this product

- To ensure correct installation, please read this guide carefully and keep in a safe place for future reference.
- Install this product in a cool, dry, clean place - away from direct sunlight and heat sources, vibration, chemical fumes, dust and moisture (steam).
- Do not expose this product to sudden temperature changes or locate it in an environment with high humidity. This is to prevent condensation forming inside which may cause damage to the product.
- Do not clean this product with chemical solvents as this may cause damage to the finish. Use a clean, dry or damp cloth.
- After installation, avoid pushing on the wall or ceiling surface immediately in front of the speaker. Excessive excursion can crack the plaster around its perimeter and can damage the loudspeaker.
- Do not attempt to modify or repair the product. Contact your distributor or Amina if a fault should occur.
- The rear of the product should not be subject to chemical cleaning and should not be painted in any way.
- Ensure that all installation mounting surfaces are able to support the weight of the BackboxCV with that of your chosen speaker.
- You will require a minimum cavity depth of 75mm behind the plasterboard to allow the use of a BackboxCV.

Environmental

- Before installing, ensure that the building is environmentally sealed, de-humidified to a maximum of RH50%, and at a stable temperature of at least 16 degrees centigrade (61 degrees Fahrenheit)
- This product should not be used with single thick coat plaster solutions or with other finishing methods that take days (rather than hours) to dry out.
- Please be aware that when this product is directly fitted into a solid brick, block or concrete wall structure (e.g. when using the solid wall backbox) vibrational energy is inevitably transferred into the solid wall structure. This energy can travel for some considerable distance up, down and along the structure. It is therefore recommended the product be fitted within acoustically isolated stud walls or ceiling sections where possible. The use of the product directly embedded in solid walls is not recommended in multi occupancy buildings.
- Please be aware that when this product is fitted in simple (stud or rafter with plasterboard/floorboard attached on either side) stud walls or wooden rafter ceiling/ floor structures, vibrational energy is inevitably transferred into the building structure. This energy can travel for some considerable distance up, down and along the structure. It is therefore recommended the product be fitted within acoustically isolated stud walls or ceiling sections where possible. Special care should be taken when installing the product in multi occupancy buildings.
- Completed and fully dried plaster surfaces should be finished with permeable coatings / materials, to allow moisture in that coating or the adhesives used to apply those materials, to dry into the environment, rather than trap moisture in the speaker.
- During installation take care to use appropriate and suitable joint filling compounds to fill the gap between speaker and the surrounding surface. This gap should be no less than 2mm and no more than 5mm in width. Inappropriate compounds used in such a joint can shrink and crack excessively and lose strength. Allow the joint to dry thoroughly before applying surface skim coats, as shrinking in the joint depth whilst drying could create a very slight embossed outline in the finished and decorated surface.
- As a general rule in the construction industry, any drying process should be gradual rather than forced with excessive heat otherwise materials can lose strength and can crack.
- Amina Technologies take no responsibility for inappropriate use of materials and environmental conditions under which they are applied.

Sound in your Home:

Amina products are widely applied in whole house audio systems and multichannel home cinemas to create the very best entertainment source whilst not impinging on the design of your home.

Never imagine though that sound reproduction is isolated to one room only and will not be heard elsewhere in the home. Sound from any audio source (a person talking, a conventional speaker, a TV or an Amina speaker) will transfer in air through open doors, ventilation structures, gaps under doors etc, to other areas of the house. Sound will also pass mechanically through the structure of the building (a good example is the central heating boiler. Most homeowners know exactly when it is on!) to other areas quite some distance away.

Whole house/multi-room audio systems are designed to give you the very best audio experience in the space/room you might occupy at any one moment. This does not mean to say that occupiers of other rooms will not hear some of that sound at the same time. They are more than likely to experience it in some lesser level and lesser quality than the intended room.

Please remember therefore that it is not always possible to enjoy the full capabilities of your audio system when other members of the household want to remain undisturbed.

Sound in your Work or Leisure Environment:

Amina products are widely applied in prestigious retail, hotel, restaurant, office, spa and other leisure facilities.

The Amina Active Sound Board technology creates an incredibly even level of sound across an entire space.

This creates an entertaining yet naturally comfortable sound field for users and occupiers.

At the same time the physical embodiment of the speaker is totally unobtrusive, allowing interior designers complete freedom from technology.

Message from the Managing Director

Congratulations and thank you for purchasing an Amina Technologies high performance invisible loudspeaker.

At Amina we are proud of being at the forefront of flat panel Active Sound Board loudspeaker technology. All the components that make up your loudspeaker have been developed specifically to provide the ultimate in sound quality and reliability, whilst allowing you to decorate, furnish and enjoy your home in any way you wish without any visible 'clutter' created by your audio system.

At the heart of an Amina loudspeaker is our high performance vibrational panel driver, featuring a unique high power neodymium magnet motor system. This enables the product to provide high quality, high loudness levels from such a compact design. Please take a moment to read this guide which will help you achieve the best possible performance from your product.

Thank you and enjoy listening.

Richard Newlove

MD - Amina Technologies Ltd

About the Manufacturer

Amina Technologies Ltd is the world's leading designer and manufacturer of truly invisible loudspeaker solutions. Our flat panel loudspeakers have been used in a wide range of both commercial and residential applications for over seventeen years.

Luxurious hotels & spas, exclusive retail outlets and stunning private residences have all benefitted from using Amina invisible loudspeakers, not only for its' incredible aesthetic quality, but for its' absolute ability to reproduce sensationally clear audio across any space. Amina has created the very best discrete audio solution for architects, interior designers and design conscious clients.

See our website for more details about Amina and a selection of prestigious projects completed using our products.

Introduction

Thank you for purchasing Amina Edge invisible loudspeakers. Properly installed, these loudspeakers will provide high quality sound for many years, even decades, to come.

Installation options

Installation is simple, but should only be attempted by professional building trades with plastering experience and who have completed an Amina installation training course.

Amina loudspeakers can not be mounted into a wall without the correct fixing accessories, supplied by Amina for each wall type.

Please read the instructions carefully, particularly the Installation section which contains important advice to select the correct wall-mounting accessories.

This manual should then be read in conjunction with the associated manual supplied with your mounting accessory.

Unpacking

Unpack the unit.

Check that your carton contains the correct number of items - a single speaker, or two if ordered as a pair.

Retain this Installation Guide. If you pass the unit on to a third party make sure you pass on the Installation Guide.

Packaging



CAUTION:

Take care when removing the loudspeakers from the carton.

The packaging for Amina Edge loudspeakers has been carefully designed to protect the product during transit. Please retain it in the unlikely event you need to return the product to your dealer or to Amina. Please recycle the packaging should you wish to dispose of it.

The outer carton is made up of 80% recycled board.

Compatibility

This installation guide covers installation of -

Amina Edge5 and Edge 7 Invisible loudspeakers within a BackboxCV345.

Amina Edge3 Invisible loudspeakers within a BackboxCV300.

Installation of any Edge loudspeaker using basic fixing blocks.

If you are installing a BackboxCV with any other type of Amina Invisible loudspeaker, refer to the General Installation guide supplied with the BackboxCV that covers all other loudspeaker models.

Overview

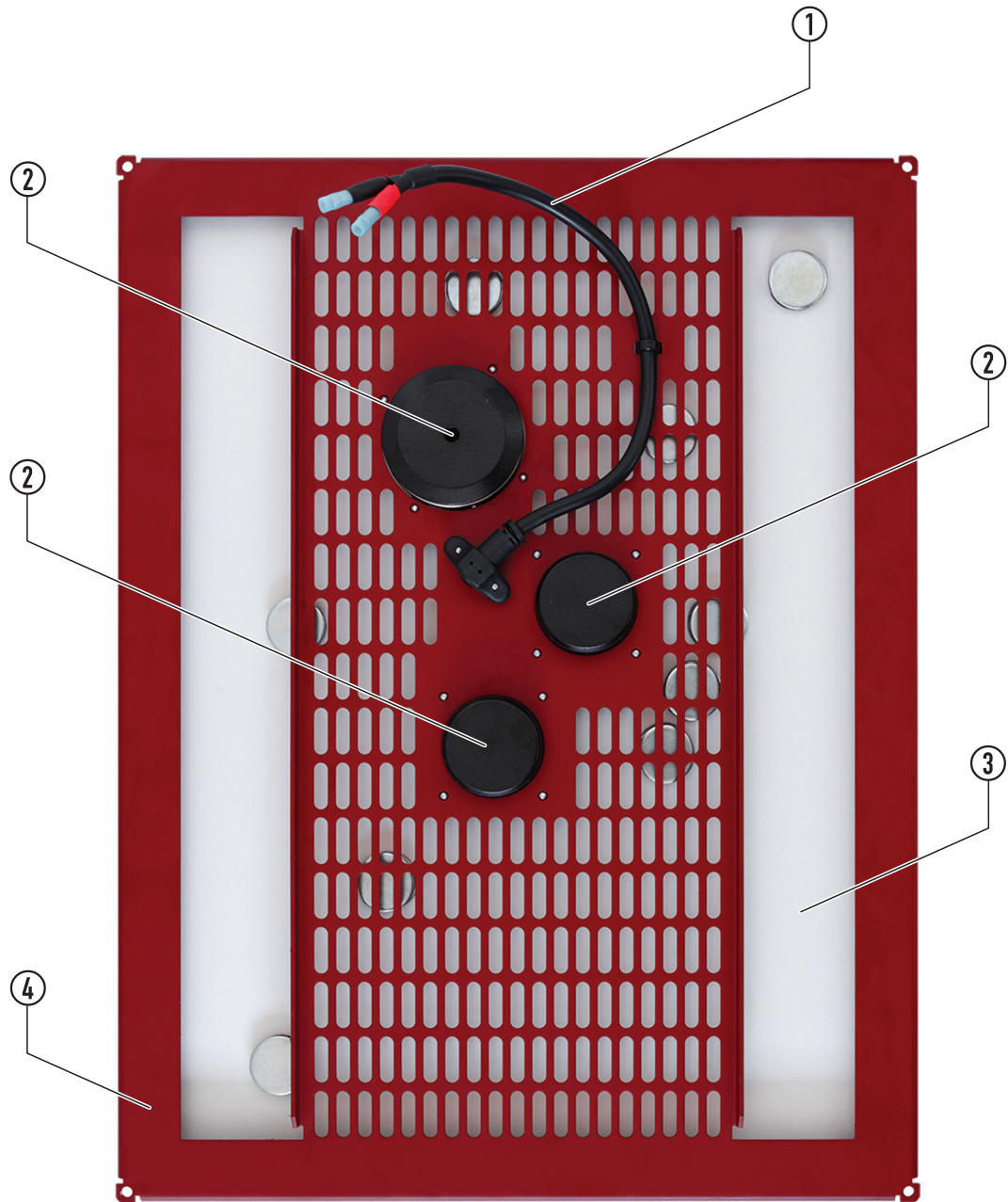

1. Electrical connection (to an amplifier, via APU)
2. High power neodymium magnet structures
3. Active panel surface
4. Aluminium chassis

Setup tips

APU protection

Amina loudspeakers must be used with an APU protection device or another protection device, approved by Amina. Please refer to the instructions supplied with the APU devices and full warranty information for further details.

Installation Backboxes

Amina Edge loudspeakers have been designed for optimum sound quality when installed with the Amina BackboxCV. We recommend that they are used wherever possible in a cavity type installation. If our basic fixing block kit is used you may find that the low/mid frequencies are reproduced less accurately, but any effect will be very much installation specific.

Wall or Ceiling Placement

Amina loudspeakers are suitable for both wall and ceiling installations. When the most uniform audio coverage in a room is required, space the loudspeakers evenly in the ceiling. However, if the room has a height greater than 6m (19'), Amina suggests installing them in the walls at a height of around 1.8m (6').

When installed into solid walls or ceilings using the Amina BackboxSW, you may find that your speaker reproduces slightly less low frequency output compared to a BackboxCV installation. Also, depending on the building construction, there may be significant mechanical sound transmission into adjacent rooms/properties (see page 5).

In dedicated listening rooms where loudspeakers are used in stereo or multi channel systems, position them in the walls so that the centre point of the speaker is approximately 1 - 1.8m (3.5 - 6') from the floor. This will give excellent results, but don't worry, if this is not possible to achieve in your room, the audio characteristics of Amina loudspeakers make exact positioning according to stereo, 5.1 and 7.1 conventions far less critical.

Audio Characteristics

Amina loudspeakers generate sound in a similar way to an acoustic musical instrument. The speaker's front face is effectively the "musical" soundboard and the sound waves generated from it are diffuse and are dispersed over a very wide angle. This means that loudspeaker positioning is far less critical than with conventional loudspeakers. Additionally, just like the acoustic musical instrument, Amina loudspeakers have excellent room filling abilities.

Amina loudspeakers are planar devices and this feature is further enhanced when flush mounted into your wall or ceiling. Being planar (or flat) means that the audio's arrival time to the listener is the same for all frequencies, i.e. there is very little phase distortion. Therefore Amina loudspeakers (and other planar devices such as electrostatic loudspeakers) can reproduce subtle nuances on a recording with incredible accuracy.

In addition to the above characteristics, the radiating surface of an Amina speaker is very stiff and undergoes very small amounts of movement in order to generate high sound pressure levels. This means that the loudspeakers are inherently "fast" making them highly articulate loudspeakers.

Setup tips

Speaker Orientation

Amina loudspeakers can be installed either in portrait or landscape orientations. Typically the spacing between wall joists will dictate portrait orientation and Amina have optimised the dispersion characteristics for this setup. Therefore when installing into walls Amina suggest portrait orientation for best sound quality.

For non-critical listening in ceiling installations the orientation of the speaker is not crucial.

For critical listening in ceilings, e.g. a 5.1 surround system, ensure that the orientation of all loudspeakers are the same relative to the main listening position and position the top of the speaker closer to the wall/ceiling boundary.

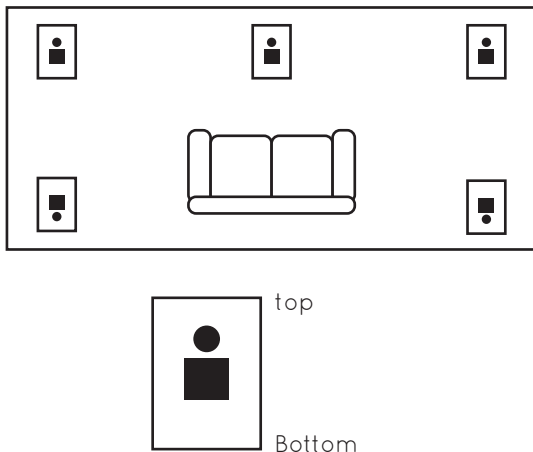

Boundary Loading

It is possible to increase the low frequency output of Amina loudspeakers by positioning them close (50mm - 150mm) to the corners of a room. This can be useful when no additional subwoofer (e.g. ALF80 or ALF120) is used.

System Requirements

From a system compatibility point of view your speaker (and it's accompanying APU protection unit) can be treated like any conventional low impedance (4-8 ohm) loudspeaker. Amina recommends you use a good quality amplifier so as to avoid driving them with high levels of distortion, which at best, will provide poor sound quality and at worst may permanently damage the loudspeaker. Amina also recommend you connect your loudspeakers to your amplifier with at least 16AWG OFC (oxygen free) cable (14AWG for long runs) to avoid any chance of reduced efficiency and restricted audio bandwidth.

For 2.1, 5.1, 7.1 and other multi-channel systems, always use the amplifier's crossover settings to divert frequencies below 100Hz to your subwoofer. This will improve the dynamic range and power handling of the system. (APU devices should still be used).

IMPORTANT: Amina loudspeakers are highly revealing of any shortcomings in the source or amplifier. Please be aware that some low cost zone amplifiers will produce high amounts of distortion well within their operating range and this will be ruthlessly revealed by Amina loudspeakers.

Sound Transmission

As with any speaker designed to be fixed to a structure within a wall or ceiling, careful consideration should be given to sound transmission into adjacent rooms or properties. We recommend specialist advice is taken if sound transmission into adjacent rooms needs to be minimised. Please talk to the Amina technical team for advice on reducing sound transmission as a starting point.

100/70V Option

For multi-speaker commercial installations, please contact Amina for their range of loudspeakers supplied with 100V or 70V line transformers fitted.

Installation



IMPORTANT: Read this section carefully before attempting to install an Amina Edge loudspeaker.

To avoid any possible damage to Amina invisible loudspeakers they must be mounted and connected using the correct accessories, supplied by Amina. The tables to follow list these accessories.

Mounting accessories

Identify the construction type of the wall/ceiling where the loudspeakers are to be installed and ensure you have the correct fixing accessories to hand before installing your loudspeakers.

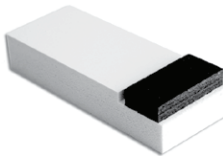
Full installation instructions are included with each type of mounting accessory.

Type	Application	Image
BackboxCV345 BackboxCV300 For cavity walls and ceilings	Used to install Edge loudspeakers in cavity walls and ceilings to reduce airborne sound generation from the rear of the speaker and create optimum acoustic cavity.	
Basic fixing block kit For cavity walls	Used to install Edge loudspeakers in cavity walls and ceilings, when BackboxCV cannot be used.	
Shims	Various thicknesses available to align the speaker with the front of non-standard plasterboard structures or for retrofit installations.	

Refer to the Installation guide supplied with the above mounting accessories for detailed fitting instructions of the accessory together with how the loudspeaker is used within it.

Installation

Speaker protectors

Amina APU series speaker protectors are specifically designed to work with Amina invisible loudspeakers. They provide essential safe operating functions and include protection elements that constantly monitor the power fed to the speaker keeping it within safe limits should the need arise.

An Amina speaker protector should be wired in-line with each Amina speaker, preferably in an accessible place, allowing this device to be replaced as necessary.



APU devices are designed to work with a single speaker. Never connect more than one speaker onto a single APU protection device.

However, common sense should always prevail. Your product should never be operated at repeated or consistently high audio levels. Never operate your Amina speaker at a level where audio reproduction appears distorted.





For the ultimate in protection and performance, use the Amina A100Q multi-channel amplifier.

Refer to the table on the next page for more detail of protection options for short to medium periods of time.

Installation

Speaker protectors

There are four types of protector.

Type	Application	Image
APU-RS8iC	Flexible 8 channel crossover and protection unit in a 1U case for optional rack mounting. Provides protection for installations of up to 8 Amina Edge loudspeakers of any type.	
APU-RS16iC	16 channel crossover and protection unit in a single 1U case. Provides protection for up to 16 Amina Edge loudspeakers of any type.	
APUiC	Single channel crossover and protection for wiring in-line with each Amina speaker. APUiC crossovers are available in different versions and must be ordered to match the speaker being installed.	
A100Q amplifier Ultimate speaker protection	Absolute protection of a loudspeaker is possible by sensing and controlling output voltages within the amplifier driving that loudspeaker. The Amina A100Q amplifier integrates clean and powerful amplification (4 channels at 100W each) with sophisticated digital sensing and control technology to deliver the ultimate protection for your Amina invisible speaker. It both prevents excessive audio signals from ever reaching the speakers whilst allowing them to perform at their absolute peak at all times. This is achieved thanks to some clever internal digital signal processing software that knows exactly how to get the best from each speaker.	

Installation

Fixing method for BackboxCV

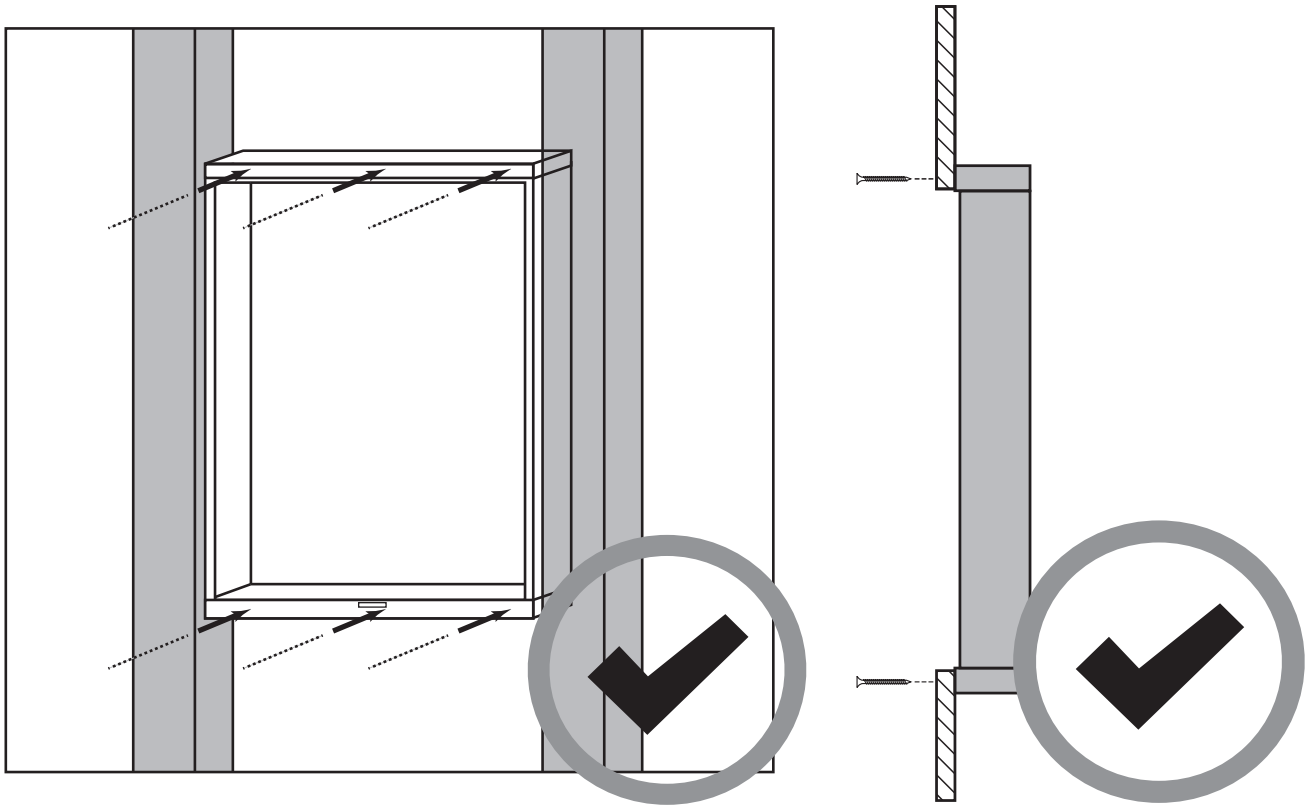

IMPORTANT:

The BackBoxCV **must** be fixed to the plasterboard only. **Never** attach directly to the stud work or near supporting structure as shown in the images below.

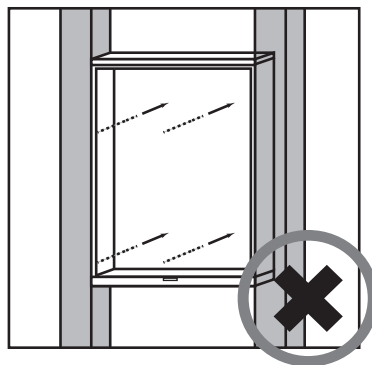
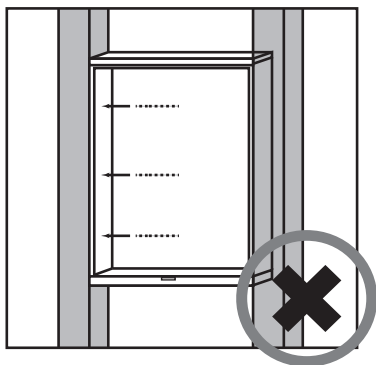

Installation

Locate joist work

When you have chosen your speaker locations, before cutting into the plasterboard it is important that you locate the position of the wall studs. Ensure the spacing between them is at least 5mm greater than the width of your Amina Edge speaker.

If necessary cut an inspection hole in the plasterboard, use a tape measure inserted through the hole to accurately locate the edges of studs.

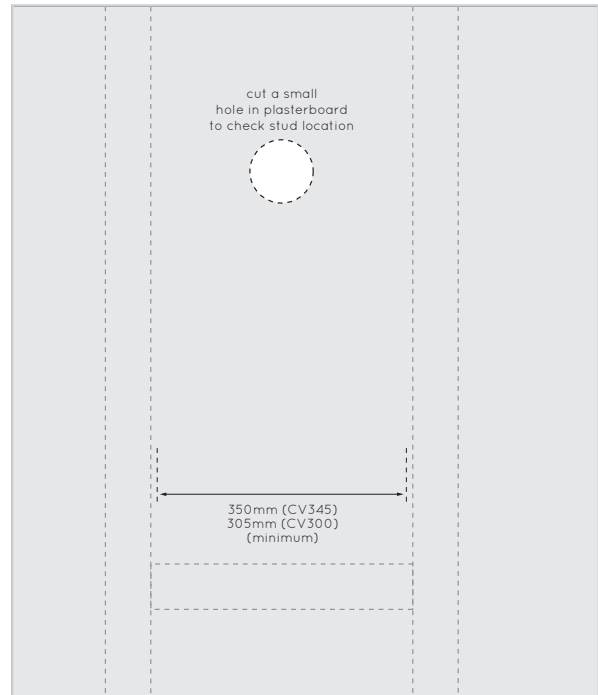

Installation

Using the Cutout Template for pre-install of BackboxCV

Staple or tape to plasterboard/drywall to act as a template.

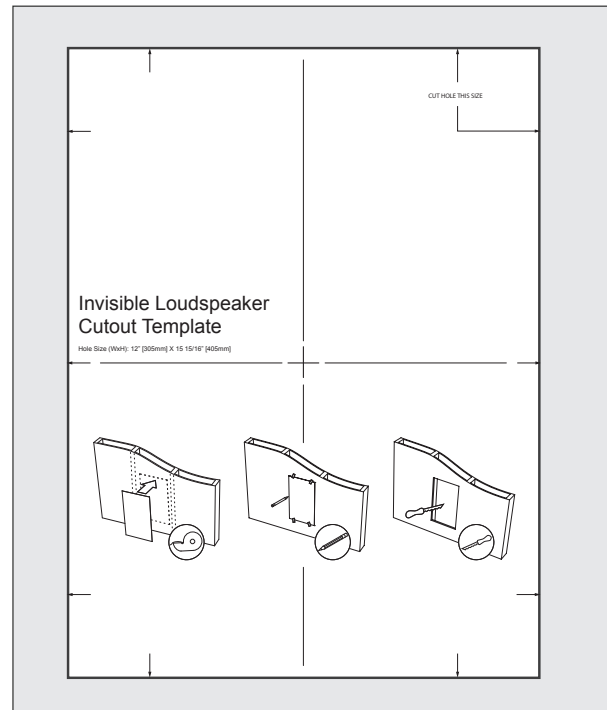

Using the Cutout Template

1. Ascertain joist position behind plasterboard/ drywall.
2. Ensure cut out dimensions fit between the joists.
3. Use a knife to cut around the outside of the template.

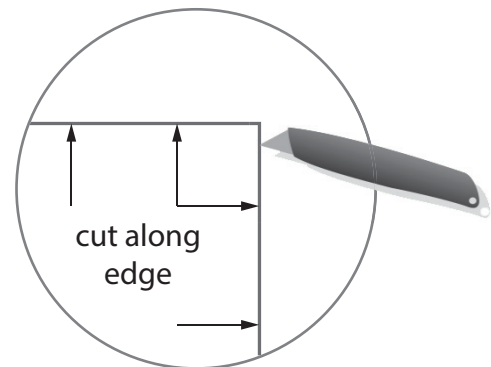

Installation

Installing the BackboxCV

Create 455 x 350mm (17 7/8" x 13 3/4") aperture (CV345).

Create 405 x 305mm (15 7/8" x 12") aperture (CV300).

Using a sharp knife or pad saw, cut an aperture in your plasterboard wall or ceiling. Ensure the aperture is created between supporting joists or stud work.

We strongly advise that joists are not cut to make space for the backbox. Any activity of this sort may well influence the structural integrity of your property.



IMPORTANT:

Double check the size of the aperture, as this is important further on into the installation process.

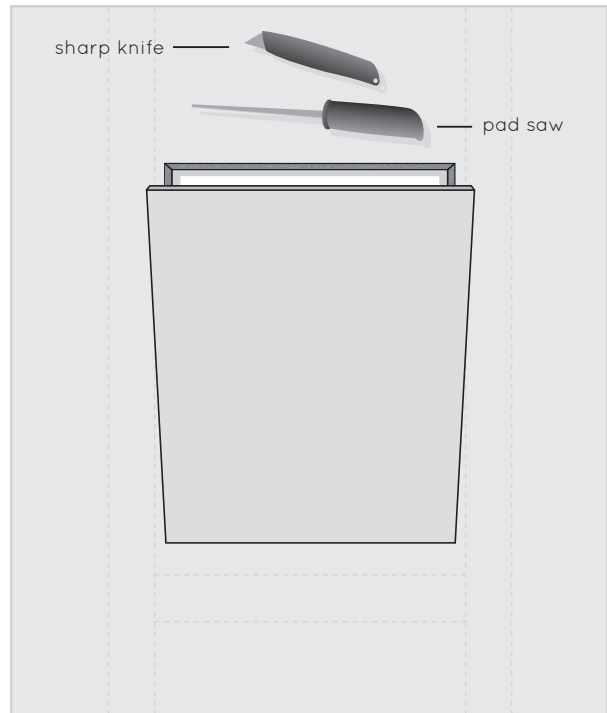

Installation

Shims

Once the hole is cut for the BackboxCV it is important to identify the construction of the wall and its thickness.

You may need to fix shims to the speaker frame or to the BackboxCV to correctly align the speaker.

The thickness of the shims required is shown in the alignment guide to follow and will depend on the construction of the wall and the thickness of plaster skim (if any).

Fixing shims to the speaker

Some installations will require shims fixed to the speaker mounting face to compensate for the thickness of plaster skim. This arrangement is shown below.

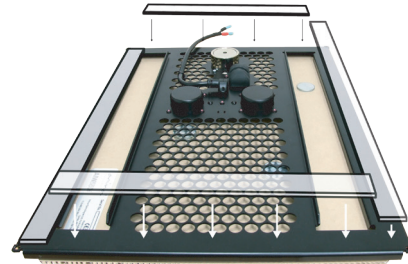

Fixing shims to the BackboxCV

Some installations will require shims fixed to the BackboxCV mounting face to compensate for thinner drywall or plasterboard. This arrangement is shown below.

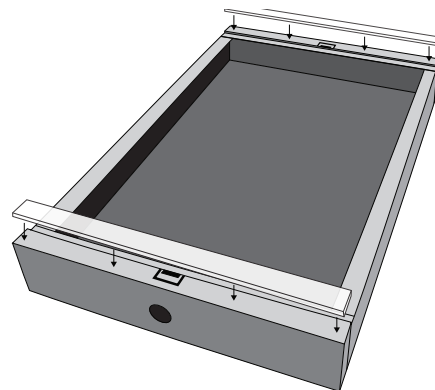

Alignment and preparation

Drywall / Dry line

For new drywall walls / ceilings

Alignment required for plastering

The diagram shows an Edge speaker fitted into a BackboxCV in a new drywall construction (not skimmed).

When correctly installed, the outer edge of the speaker panel will align with the drywall surface around the speaker and the raised centre section of the speaker panel will sit 0.8mm ($\frac{1}{32}$ ") in front of the drywall.

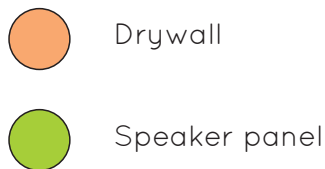

Shim sizes
<p>Standard 12.5mm ($\frac{1}{2}$") drywall</p> <p>No shims are required for installation in 12.5mm ($\frac{1}{2}$") drywall. For other drywall thicknesses, shims will be necessary.</p>
<p>Thicker drywall</p> <p>For thicker drywall, subtract 12.5mm ($\frac{1}{2}$") from the thickness of the drywall to determine the shim size. Fix the shims to the mounting face of the speaker.</p>
<p>Thinner drywall</p> <p>For thinner drywall, subtract the drywall thickness from 12.5mm ($\frac{1}{2}$") to determine the shim size. Fix the shims to the mounting face of the BackboxCV.</p>

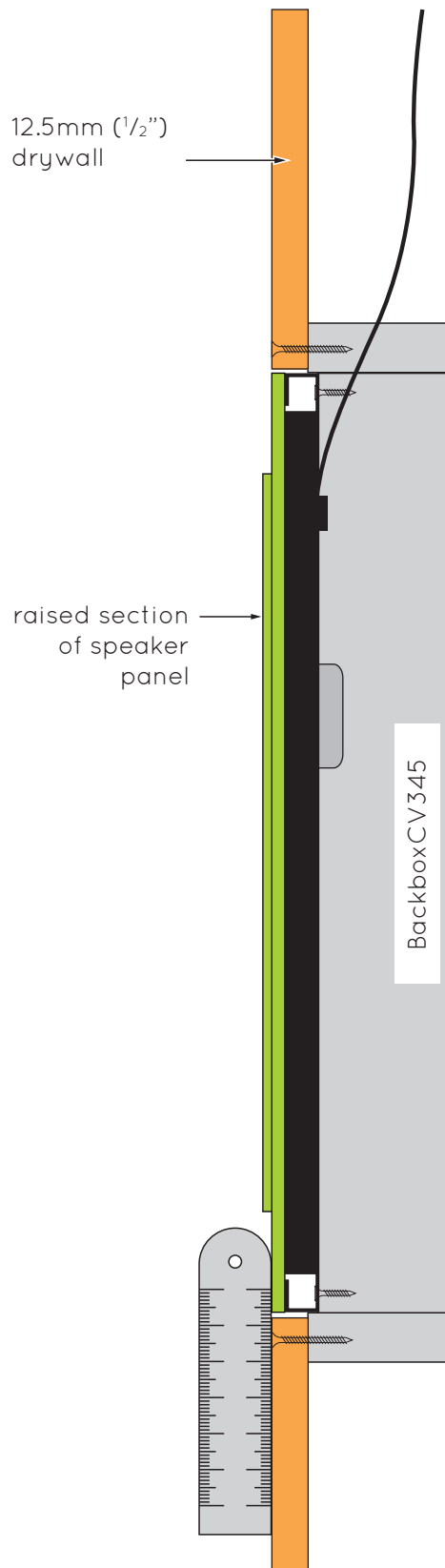

Alignment and preparation

New plasterboard walls (yet to be plastered)

For new plasterboard walls / ceilings that have not yet been plastered.

Pre-plaster the walls

When working with new plasterboard walls it is advisable to completely plaster the wall and allow it to dry fully before starting work to install the speaker(s).

The diagram on this page illustrates a wall prepared in this way.

Once dry, follow the instructions from pages 16 - 18 to locate joists, then cut an aperture for the BackboxCV.

The BackboxCV and speaker can then be fitted by following the Retrofit/Pre-skimmed installation instructions on pages 22-24.

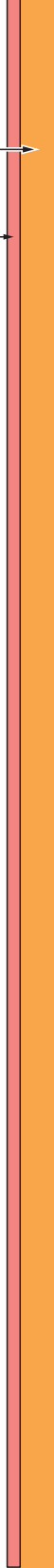

12.5mm (1/2")
plasterboard

plaster skim

 Plasterboard

 Plaster

Alignment and preparation

Retrofit / pre-skimmed plasterboard

For walls / ceilings that have already been plastered.

Retrofit alignment options

The unique design of the Edge loudspeaker allows a choice of two alignment options when retro-fitting an Edge speaker and BackboxCV into a plastered wall.

Flush with surround

You can choose to align the surround of the speaker panel to the plaster surface as shown here.

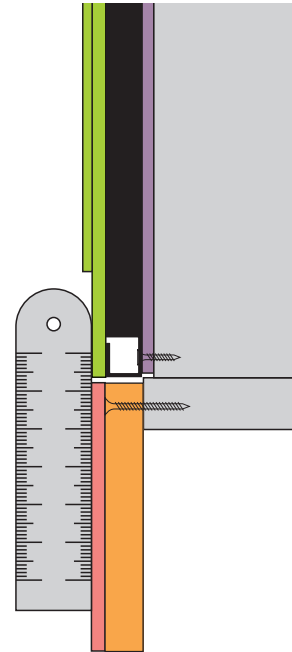
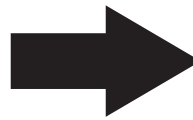

Flush with centre

Alternatively, you can adjust the shims to set the speaker further back in the BackboxCV to align the raised section of the speaker panel to the plaster surface.

With this type of installation, remove approximately 25mm (1") width of plaster around the perimeter of the opening to allow space for joint tape.

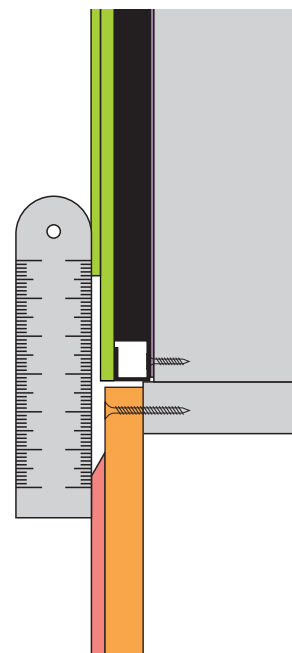
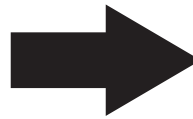

The next two pages show more detailed drawings of these two methods of installation.

Alignment and preparation

Retrofit / pre-skimmed plasterboard (Flush with surround)

For walls / ceilings that have already been plastered.

Alignment required for plastering

The diagram shows an Edge speaker fitted into a BackboxCV in a pre-skimmed wall constructed of plasterboard.

When correctly installed, the outer edge of the speaker panel will align with the plaster surface around the speaker and the raised centre section of the speaker panel will sit 0.8mm ($\frac{1}{32}$ ") above the plaster surface.

To achieve this alignment, shims of the correct size are required when fitting an Edge speaker into a BackboxCV.

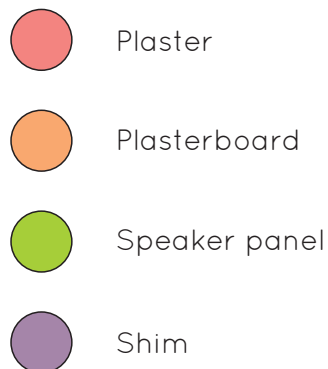

Shim sizes

Shims will be required to space the speaker out to meet the face of the plastered wall.

To determine the exact size of shim required, measure the thickness of the wall including plaster and subtract 12.5mm ($\frac{1}{2}$ ").

For example, if the wall thickness measures 14.5mm ($\frac{9}{16}$ "), the shim thickness required will be 2mm.

The shims are fixed to the mounting face of the speaker (see page 19).

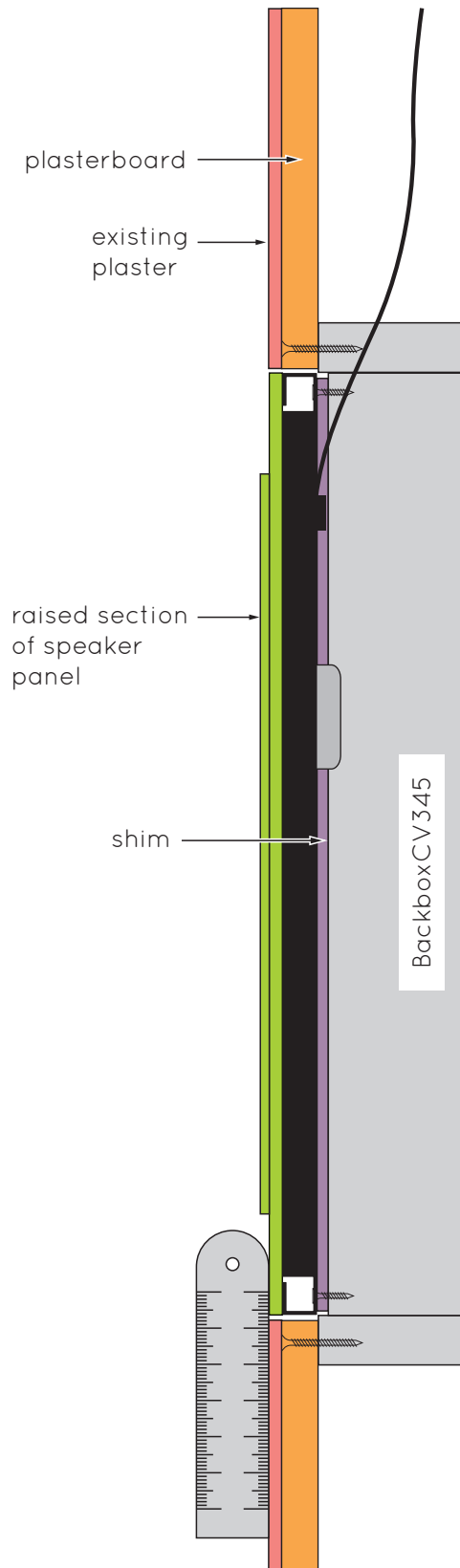

Alignment and preparation

Retrofit / pre-skimmed plasterboard (Flush with centre)

For walls / ceilings that have already been plastered.

Alignment required for plastering

The diagram shows the same 'Retrofit' installation as page 23, but to achieve a flush finish the raised section of the speaker is aligned with the surrounding plaster.

To achieve this alignment, shims of the correct size will be required.

Approximately 25mm (1/2") width of plaster should be removed around the opening before fitting the speaker, to make room for the application of joint tape.

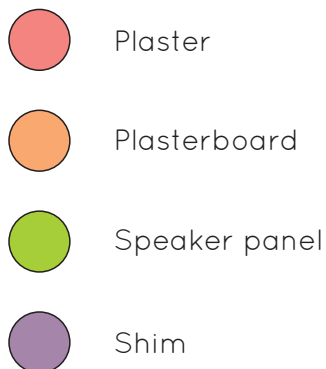

Shim sizes

Shims will be required to space the speaker out to meet the face of the plastered wall.

To determine the exact size of shim required, measure the thickness of the wall including plaster and subtract 13.5mm (17/32").

For example, if the wall thickness measures 14.5mm (9/16"), the shim thickness required will be 1mm.

The shims are fixed to the mounting face of the speaker (see page 19).

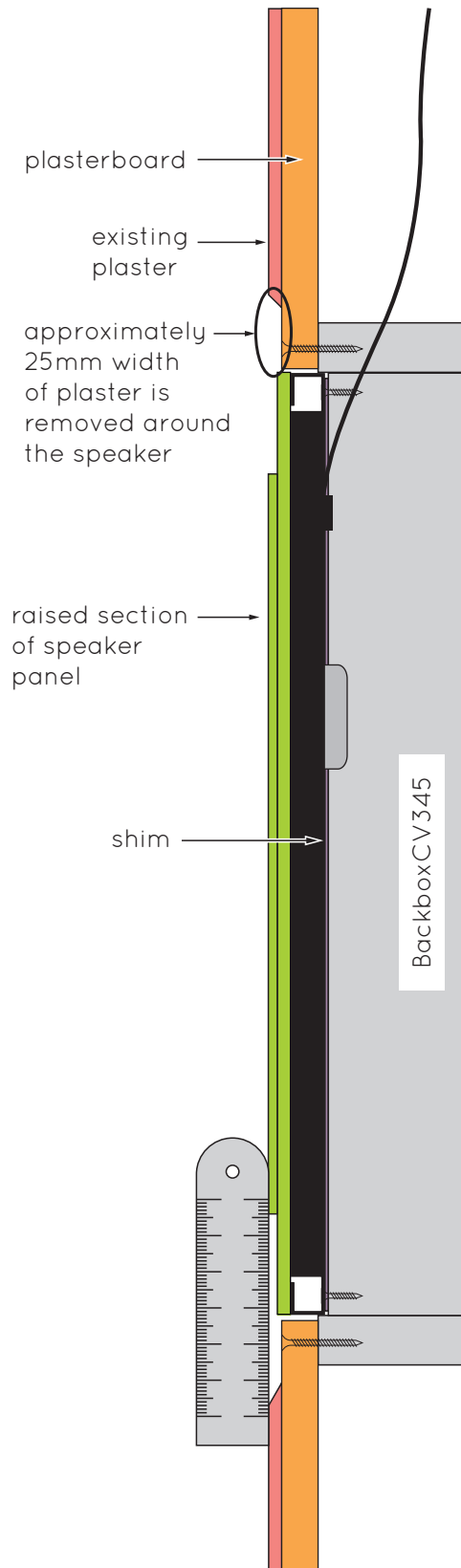

Alignment and preparation

For new stud walls / ceilings using Fixing Blocks

Alignment required for plastering





Fixing blocks are used in installations where BackboxCV cannot be used.

The diagram shows an Edge loudspeaker fitted in a new stud wall with Fixing blocks.

When correctly installed, the raised surface of the speaker panel will align with the surface of the surrounding plaster.

A shim may be necessary as shown to achieve the correct alignment.

The cavity behind the speaker should be packed with acoustic wadding to reduce back radiated sound.

-  Plasterboard
-  Speaker panel
-  Fixing block
-  Shim

The view below shows a speaker fitted with Fixing blocks. The plasterboard is cut away from the top right Fixing Block to show correct alignment of the block behind the plasterboard.

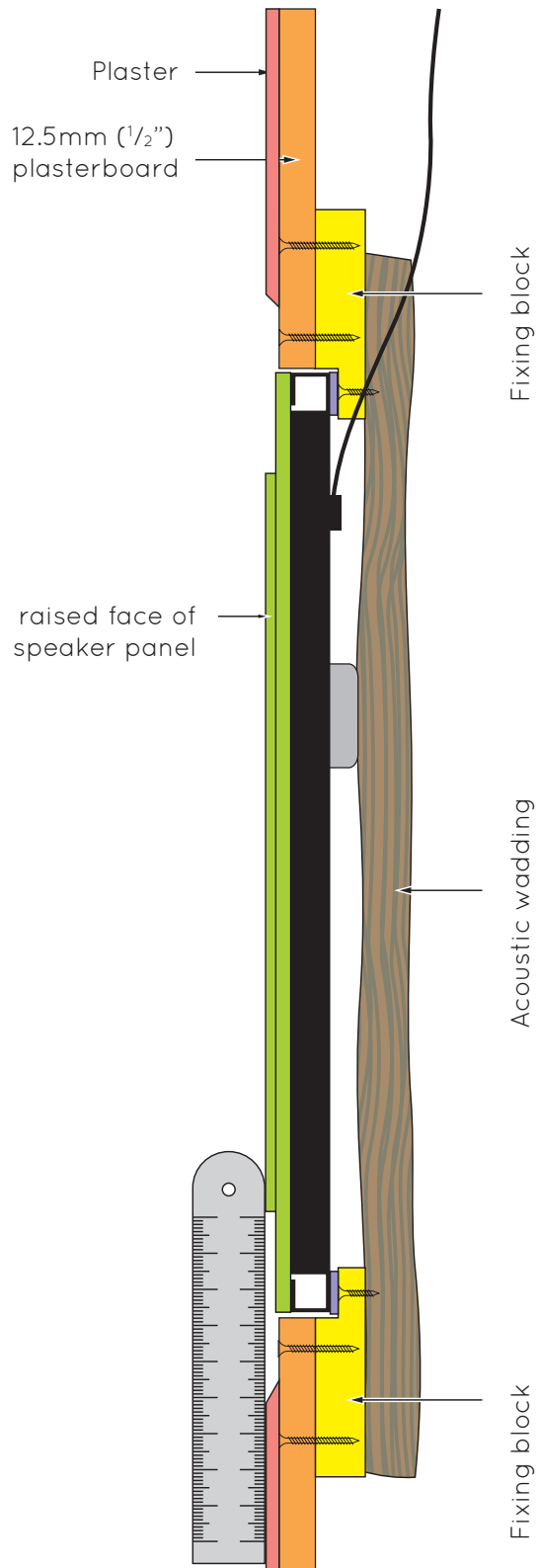
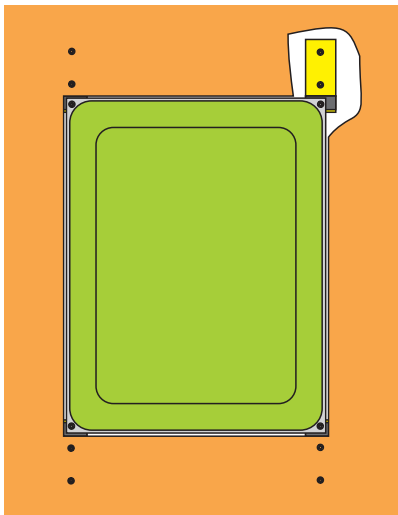

Testing

Testing the speaker

At this stage the speaker must be tested. If any problems are found the speaker can be easily removed before plastering.



CAUTION:

Do not use a battery or DC voltage supply to check continuity or phase check as there is no forward or backward movement of the panel.

DC voltage can damage the speaker.

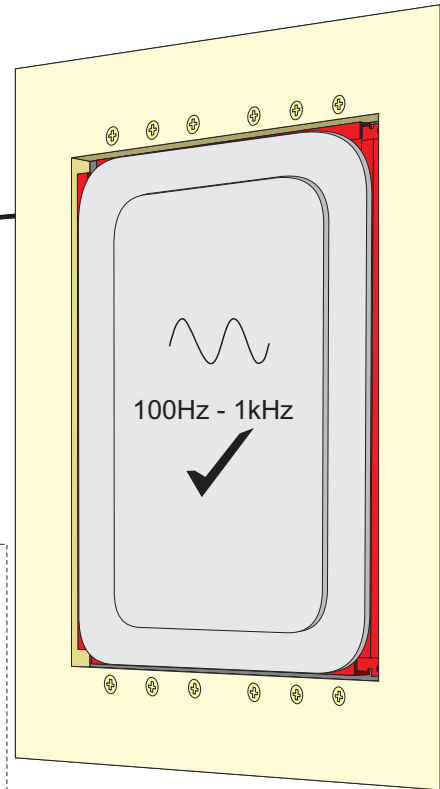
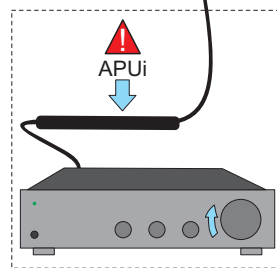

Resistance test

Using a multimeter and without the APU protection device connected, check the nominal impedance (DC resistance) of the speaker at the amplifier end of the speaker cable.

Allowing for approx. +10% for cable resistance, the measured impedance should coincide with the values on the respective loudspeaker datasheets.

If it measures significantly differently, check for breaks or shorts in the cable.



CAUTION:

Connect the APU protection device

Once the resistance test is successfully completed, connect the APU protection unit at the amplifier end of the cable before proceeding with further tests.

Sweep test

Amina recommends a tone sweep be used at a moderate volume level (0.5 Vrms). Such a test will quickly highlight any buzzes or rattles that could be caused by loose screws, cables touching the speaker or loose elements/studs within the wall/ceiling itself.

NOTE: A tone sweep test must be run initially as it is the most reliable test for buzz and rattle. Music tests are useful, optional tests for final confirmation.

Music test

Play music to check for buzzes and rattles during transient peaks: if these are apparent, check the above points again. The overall speaker performance must be clean and distortion free.

Problems during test

If the tests reveal any rattles or buzzes, refer to the next section for help to find the cause.

Testing

Problems during test

if you encounter any rattling or buzzing problems during test, check the following section to resolve these issues.



CAUTION:

Never proceed with plastering until the speaker has passed both sweep and music tests.

The following list may help you trace the cause of any rattling or buzzing problems.

Insecure drywall

If the drywall is not securely fastened to the joists, this could create a buzz or a rattle. Apply more screws to secure the drywall if necessary - particularly around the speaker location.

Metal studs

If metal studs are used, ensure all crossover points within the studs are secured together. This can be achieved by applying drywall screws through the wall surface and through the metal crossover points.

If they are not secure this may well lead to audible vibrations and rattles.

Cable buzzing

Ensure that the speaker cable is not touching any part of the speaker as this can lead to buzzes and rattles. To avoid this it is advised to lay the cable behind mineral wool, recycled cotton or other wadding.

Lighting fixtures

Ensure lighting fixtures, especially those closer to the loudspeakers are of a solid construction and are firmly fixed in place.

Finishing

Filling the perimeter

Once the speaker is fixed into place, the gap must be filled with plaster to bond the edge of the panel to the edge of the plasterboard.

Wipe away filler from the panel surface (both the outer perimeter and raised sections).

Use a low shrinkage repair plaster such as British Gypsum Gyproc-Joint-Filler or other similar joint compound.



Allow this to dry fully before continuing with the installation.



Speaker panel



Plaster to fill the edge

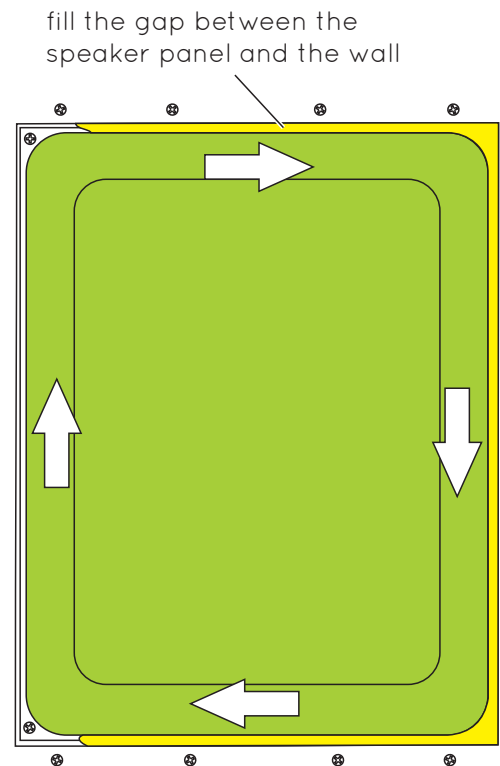

Taping the joints

Using 50mm (2") plaster jointing scrim tape, tape across the perimeter of the speaker frame as shown.

Prior to taping, wipe the surface clean with a damp cloth and allow to dry.

Paper tape can also be used. Use usual methods to apply paper tape (wetted if necessary and set into wet joint compound).



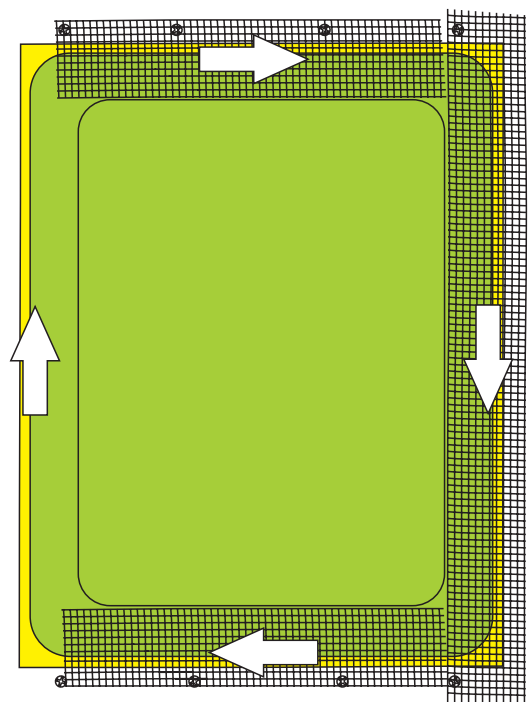

NOTE: Place the joint scrim as close to the raised front surface as possible.



Finishing

Feathering the panel edge

Feather in plaster to the edge of the raised section.

-  Speaker panel
-  Plaster to fill the edge
-  Feathered surface filler skim
-  Original plaster
-  Plasterboard

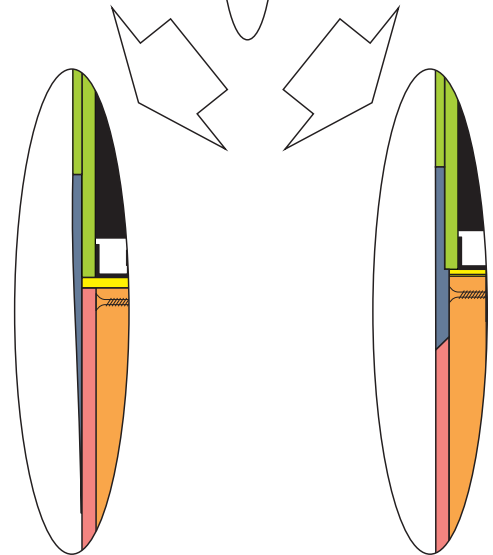
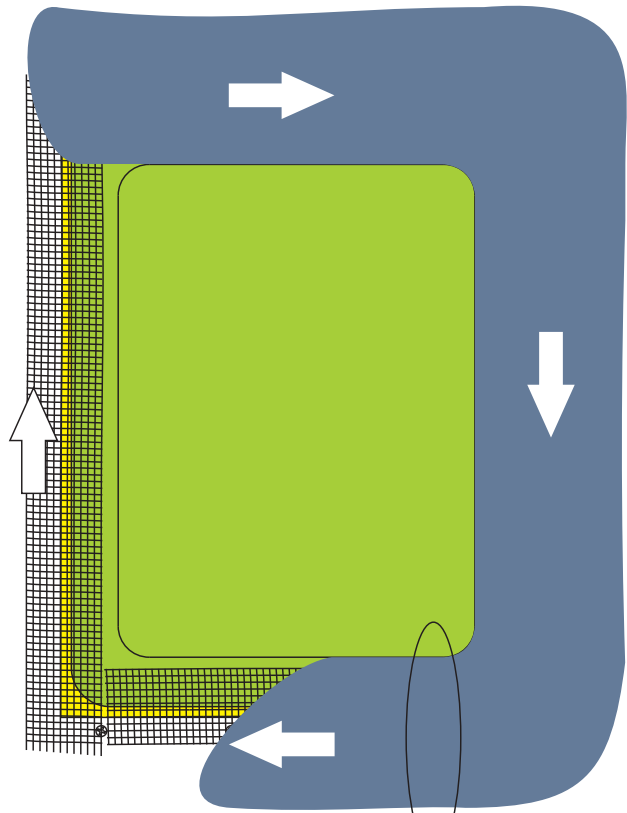

Flush surround

Flush centre

Cutaway view

This cutaway view shows a section through the finished skim in the area shown.

Finishing

Fine surface finishing (optional)

To finish the installation, a very light coat of fine surface filler, less than 0.5mm (1/64") may be used over the entire front surface of the speaker to blend the panel appearance with the surrounding plaster.

Amina recommend using Toupret® ready mixed fine surface filler.

Filler can be sanded/wiped smooth to achieve the correct texture. Care should be taken not to sand any exposed paper panel surface.

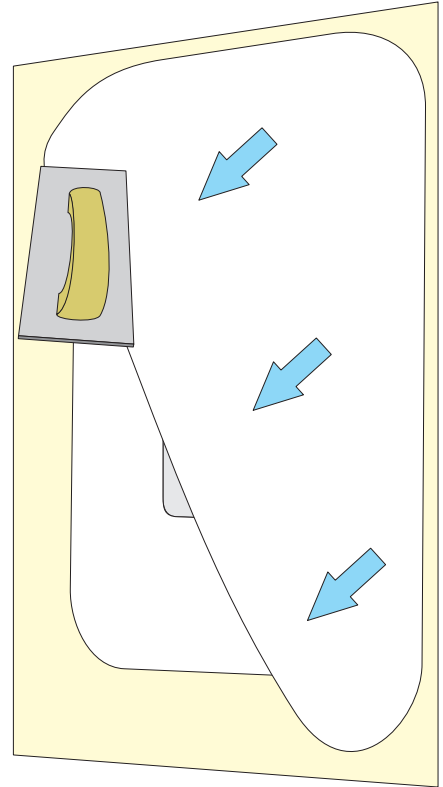

Decorating

Allow your plasterwork to dry completely. Test the speaker again. You can then paint the surface or hang wallpaper in the usual manner.

Amina Invisible speakers have been optimised for three coats of emulsion once plastered. Additional coats will cause very small reductions in the maximum sound pressure levels achievable.

Completed and fully dried plaster surfaces should be finished with permeable coatings / materials to allow moisture in that coating or the adhesives used to apply those materials, to dry into the environment quickly.

Oil based coatings and other non-permeable surfaces will trap moisture in the plaster surface for many days and even weeks. This has the potential to work its way back to the Amina loudspeakers exposing them to an unacceptably damp environment for an extended period.

The use of impermeable coatings and materials should be considered carefully and with caution. Bare plaster surfaces must be pre-treated with a primer / sealing coat that is permeable during its drying process. The entire surface must then be fully dry (this may take some weeks) before applying the impermeable coating or material.

Ensure the building is environmentally sealed, de-humidified (to a max of RH 50%) and at a standing temperature of at least 16°C (61°F).

Maintenance and cleaning

Once your speaker is plastered into your wall or ceiling, it requires no physical maintenance. Your wall or ceiling can be cleaned with products appropriate to the finish finally applied to the plaster surface.

Re-decoration

The wall or ceiling can be painted or redecorated any number of times, but please be aware that sound output will reduce very slightly with each coat. Extreme care should be taken when removing wallpaper type coverings to ensure the panel surface is not damaged. If damage to the plaster work occurs, use repair plaster to restore the plaster surface prior to re-decorating. Amina Technologies Ltd recommends British Gypsum Gyproc-Joint-Filler as a repair plaster.

Avoid pushing the wall or ceiling surface immediately in front of the speaker. Excessive excursion, whilst unlikely to damage the speaker, can cause the plaster to crack around its perimeter and can ultimately damage the loudspeaker.

Fire resisting installation

The Amina Edge 7 loudspeaker is certified for installation in areas where fire compliance is required to standard BS476 Pt 21: Timber floors.

This will generally be in multi-level buildings such as offices, apartments and flats where the ceiling and any fittings in the ceiling must maintain a 60 minute barrier to fire.

The fire rated ceiling should be built in accordance with the British Gypsum white book specification for 60 minute ceilings.

To meet the requirements of this standard, and to ensure a full 60 minute rating, the Edge loudspeaker and Backbox must only be installed in accordance with the instructions in this section.

The cross-section views that follow illustrate the completed installation of an Edge loudspeaker in a ceiling. Study these before commencing installation.

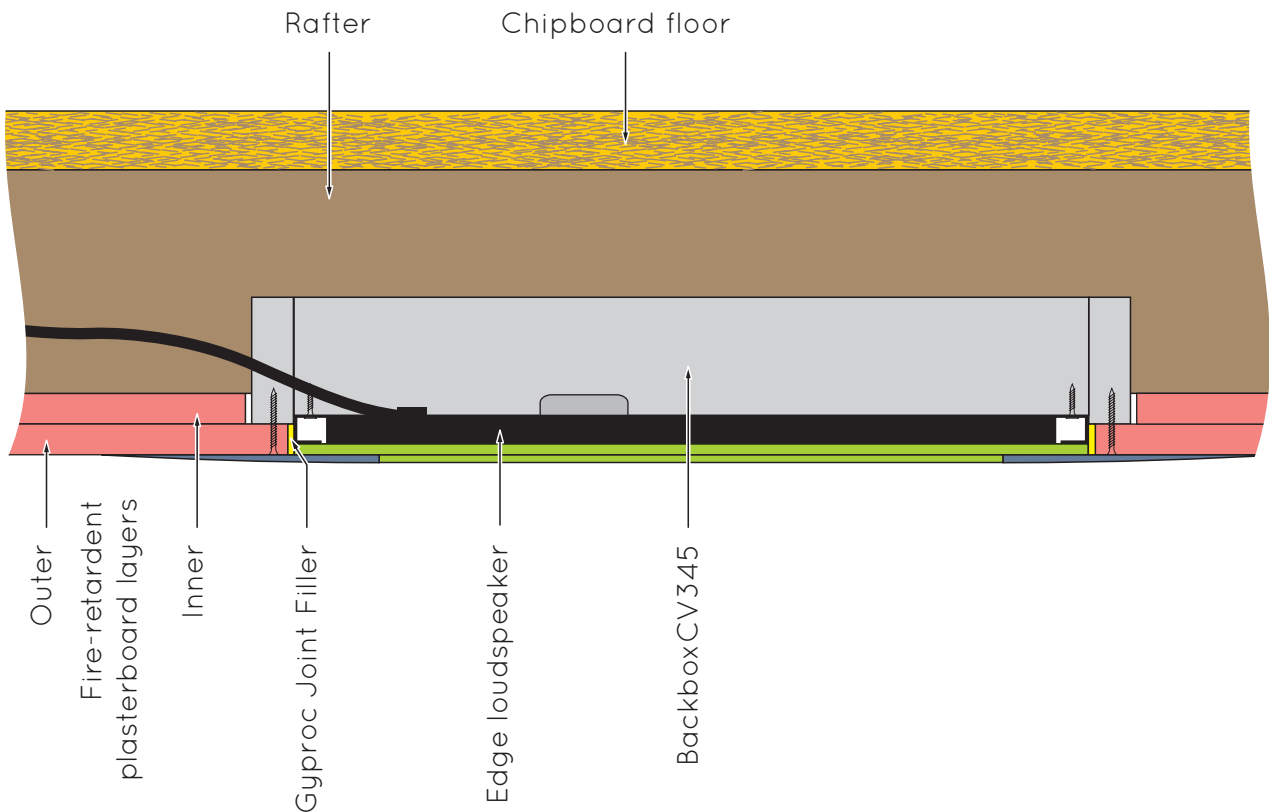

Loudspeaker panel



Fire-retardant plasterboard



Gyproc joint filler



Plaster

Fire resisting installation

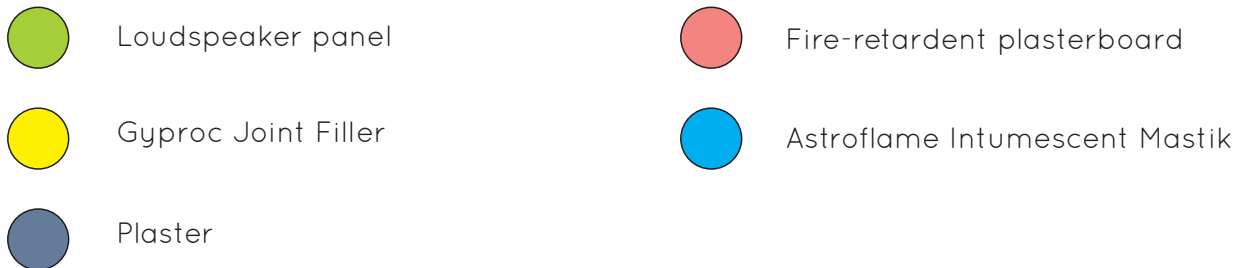
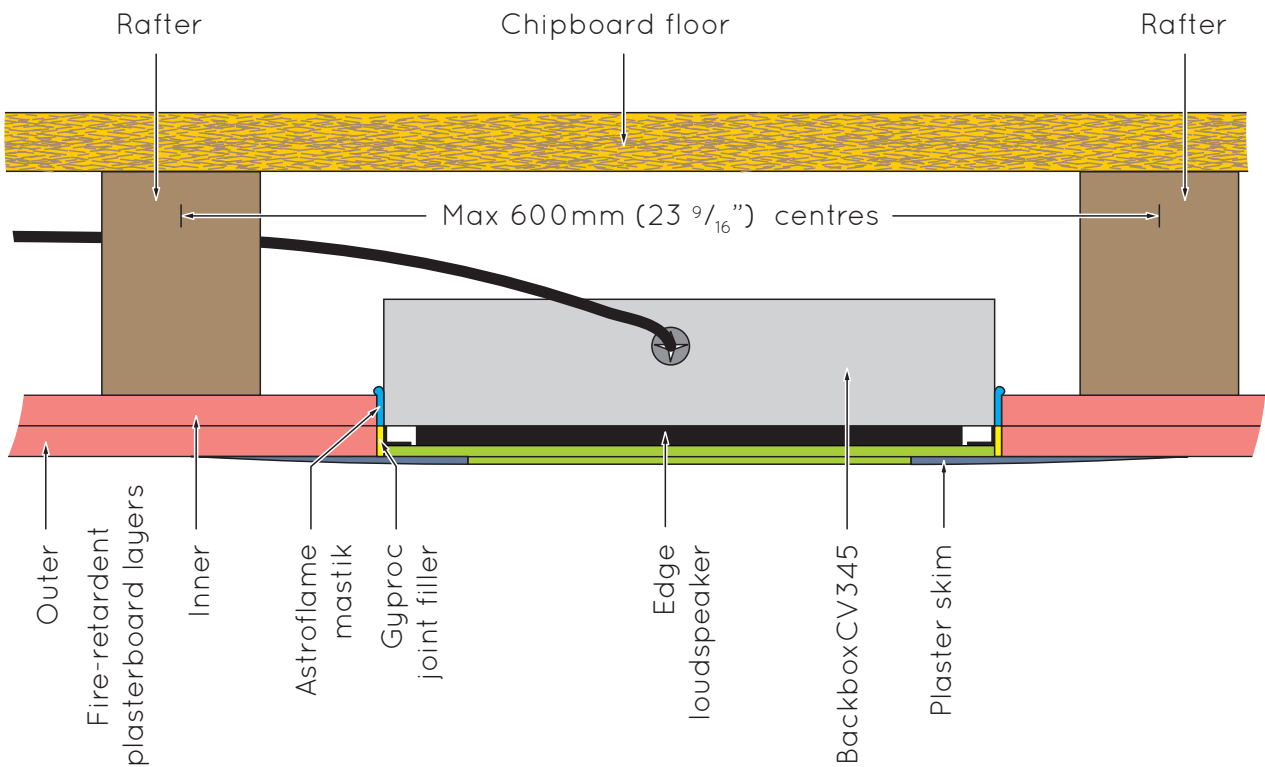

Pre-installation checks

Materials must be the correct grade for fire-retardant installation.

Plasterboard must be the correct 60 minute grade of fire-retardant plasterboard. This is usually coloured pink.

The plasterboard must be 12.5mm (1/2") thick to achieve the correct alignment of the loudspeaker with the ceiling.

Spacers must not be used in fire-retardant installations.

To preserve the fire barrier, filler and sealant must only be the types specified.

Plan the locations for the Edge loudspeakers. Ensure there is clearance around each loudspeaker position from rafters and any other fittings in the ceiling.

CAUTION: Under no circumstances cut the rafters or fix the BackboxCV to the rafters in any way. The BackboxCV must be fixed only to the outer layer of plasterboard.

Fire resisting installation

Installation

1. Route a cable from the location of the amplifier through the ceiling space to the location of each loudspeaker. Ensure that there is enough free cable length available to allow each speaker to be connected.

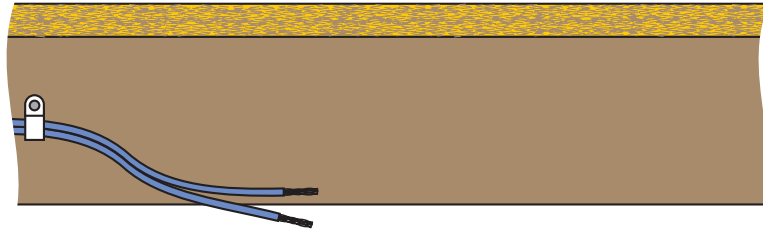

2. Fix the first layer of fire-retardent plasterboard to the rafters.

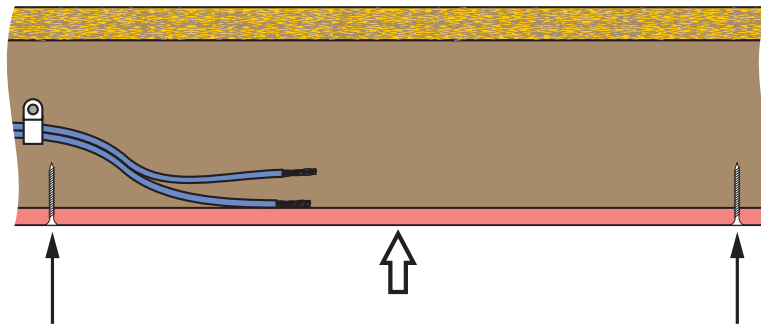

3. Using a sharp knife or pad saw, cut an aperture in the plasterboard at each speaker location. The BackboxCV will pass through these holes so cut them to 502mm x 350mm (19 3/4" x 13 3/4")

To maintain a fire barrier the BackboxCV must fit into the opening with minimal clearance.

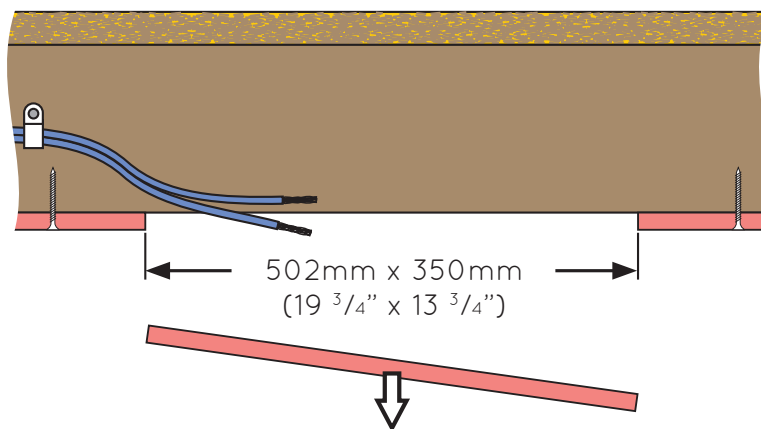

Fire resisting installation

4. Fix the outer layer of plasterboard over the first layer.

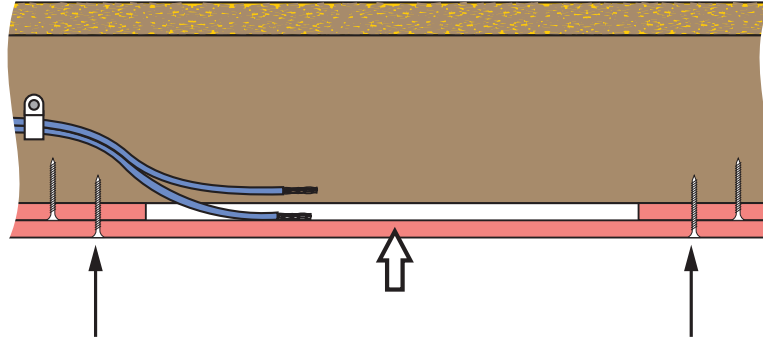

5. Cut a smaller 452 x 347mm (17 7/8" x 13 3/4") aperture in the outer layer of plasterboard, centred on the apertures in the inner plasterboard layer.

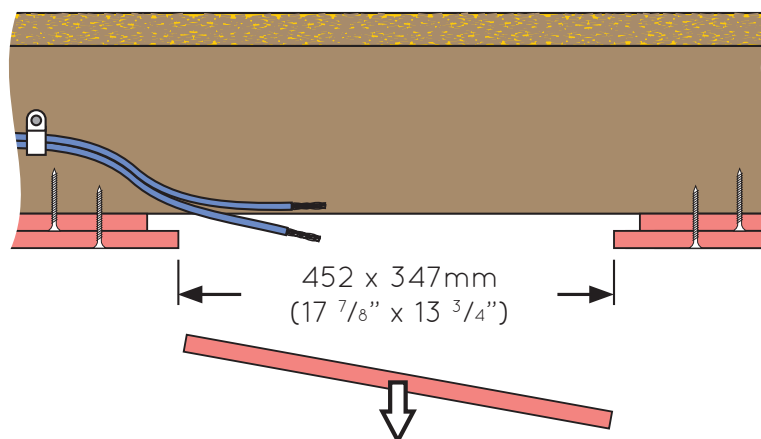

6. Feed the cable through the grommet in the BackboxCV and lift the BackboxCV into position through the opening. Drop the BackboxCV into place to rest on the outer layer of plasterboard.

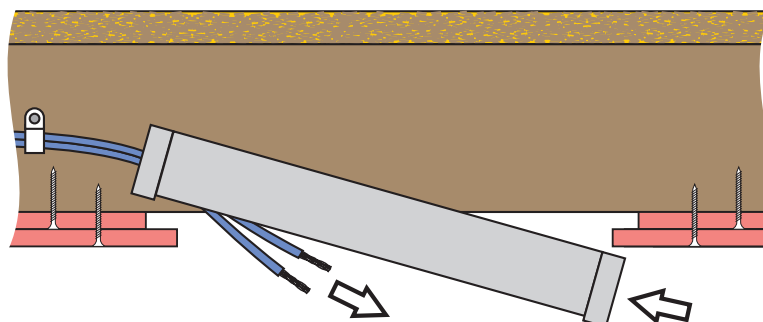

Fire resisting installation

7. Fix the BackboxCV into position with four to six screws fitted through the end flanges.

NOTE: No shims are necessary when fitting an Edge speaker into 12.5mm (1/2") plasterboard in this way.

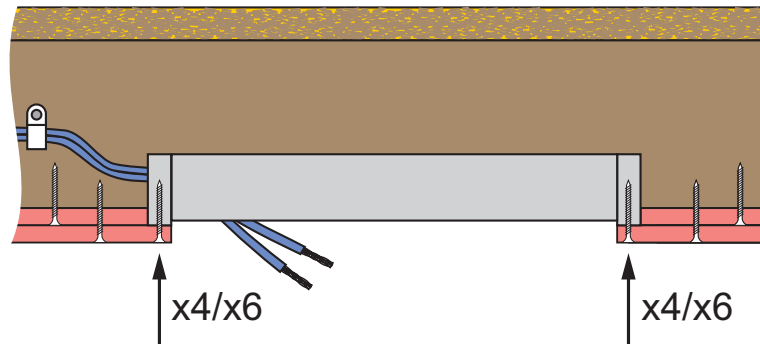

8. Thoroughly seal any gaps between the long edges of the BackboxCV and the inner layer of plasterboard with Astroflame Intumescent Mastik.

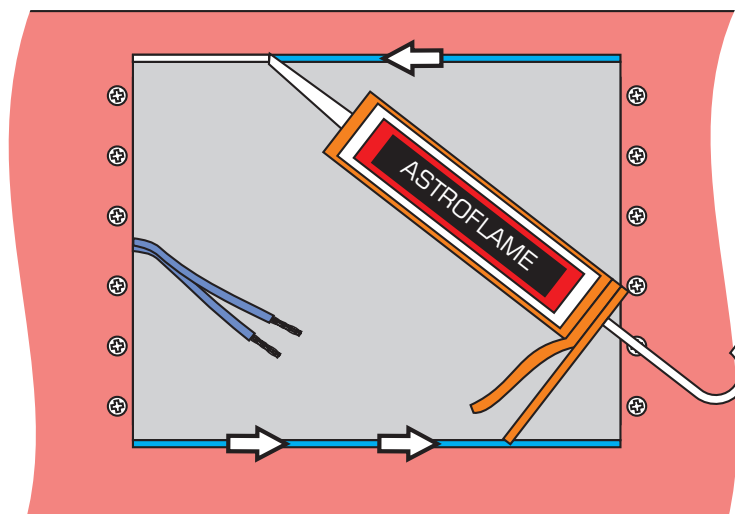

The Astroflame Intumescent Mastik must only be applied to the two long edges of the BackboxCV as shown, never to the short edges.

Fire resisting installation

9. Connect the speaker cable to the butt splice terminals on the loudspeaker wiring. Ensure that the polarity of the connections is correct, then crimp the wires to complete the joints.

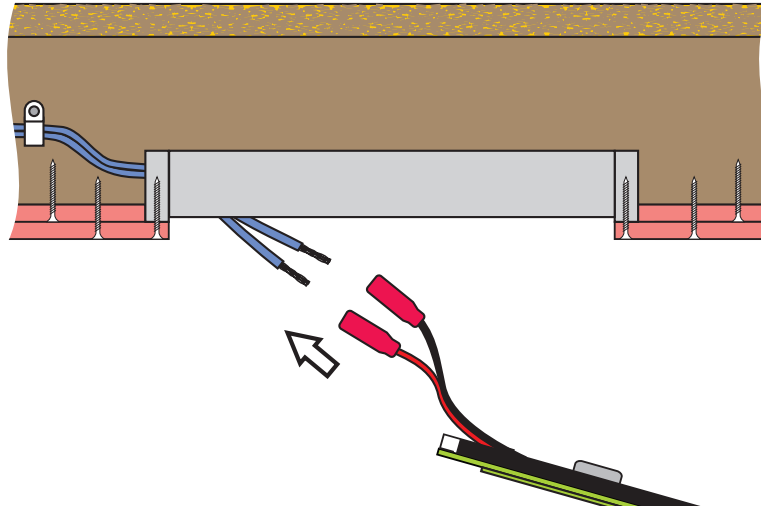

10. Screw the loudspeaker into place in the BackboxCV.

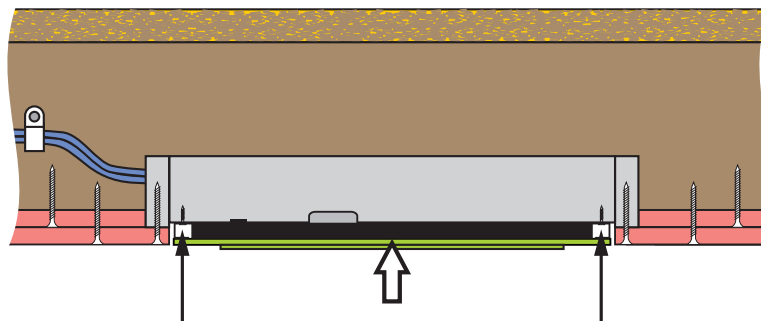

11. Follow the instructions on page 26 to fully test the loudspeaker. Impedance tests, Sweep tests and Music tests should all be completed before filling the panel edge.

Fire resisting installation

- Working from the face of the loudspeaker, fill the gap between the loudspeaker panel and plasterboard with Gyproc Joint Filler. Allow the filler to dry thoroughly.

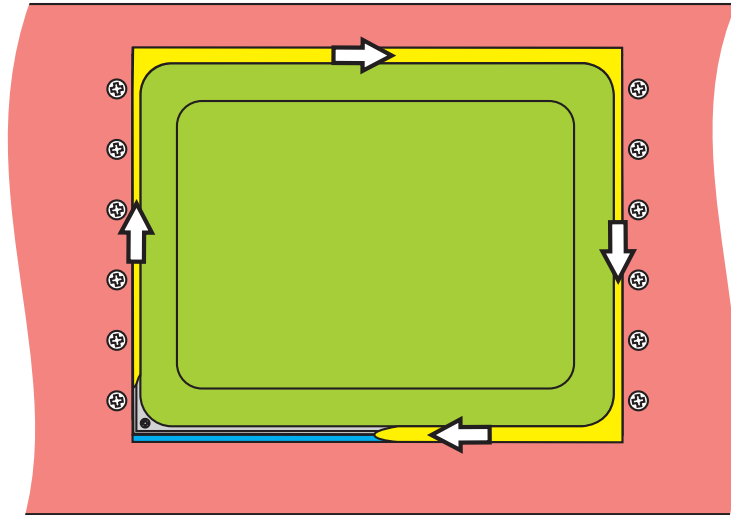

- Using 50mm (2") plaster jointing scrim tape, tape across the perimeter of the speaker frame as shown.

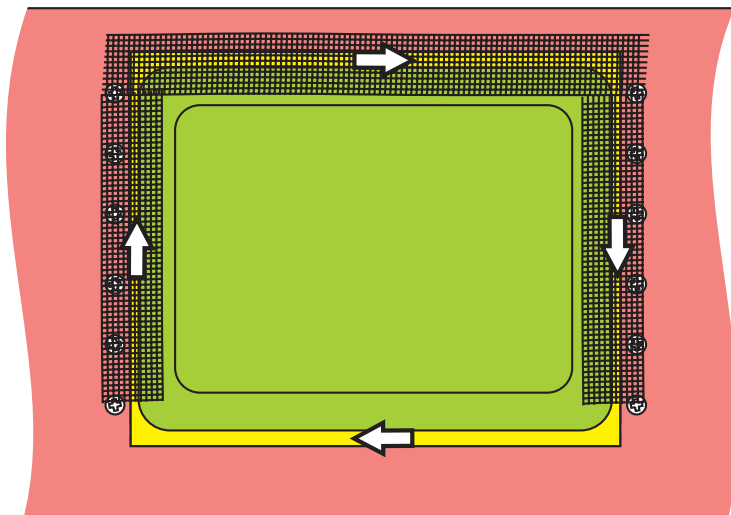

Fire resisting installation

14. Feather in plaster to the edge of the raised section to complete the installation. Use British Gypsum Gyproc joint filler for the first coats, finish with a fine surface filler.

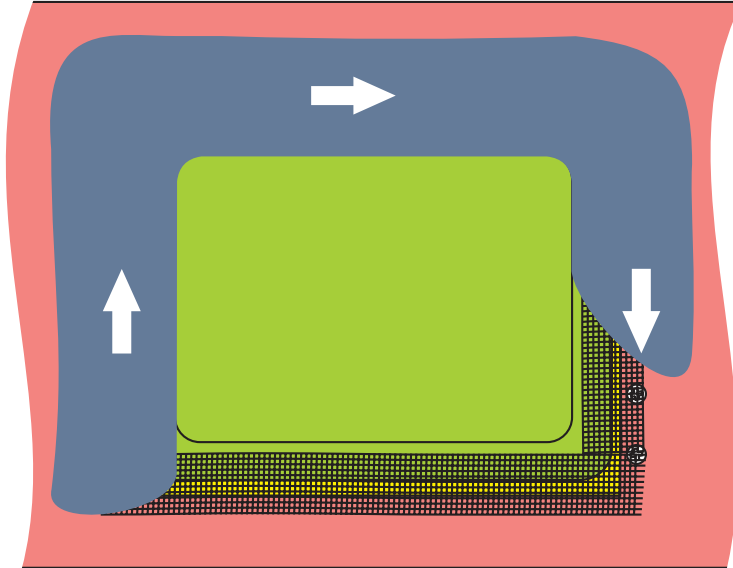

15. To finish the installation, a very light coat of fine surface filler, less than 0.5mm (1/64") may be used over the entire front surface of the speaker to blend the panel appearance with the surrounding plaster. Amina recommend using Toupret® ready mixed fine surface filler. Filler can be sanded/wiped smooth to achieve the correct texture. Care should be taken not to sand any exposed paper panel surface.

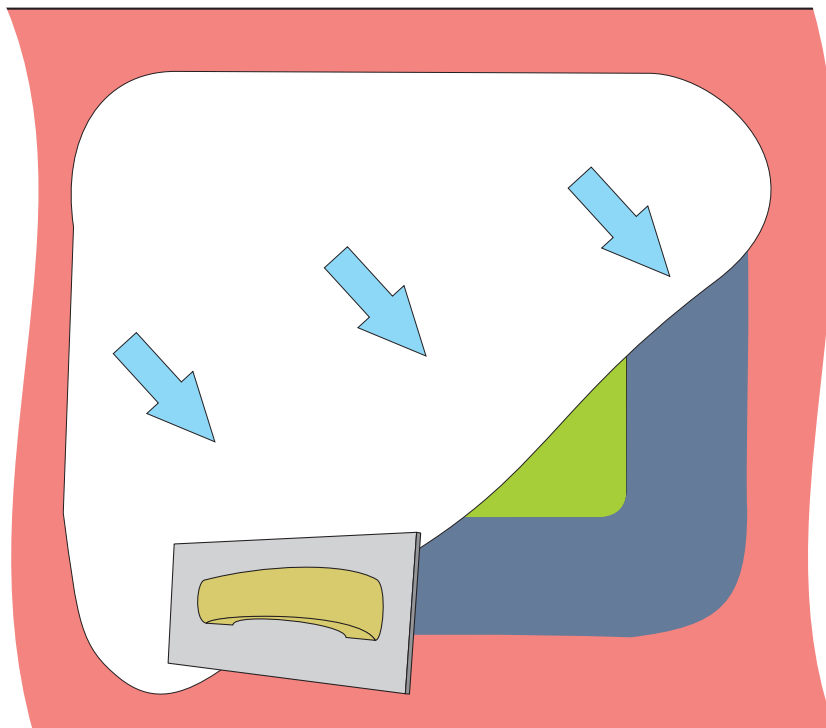

16. When the plaster has fully dried, re-test the loudspeaker as before.

Fire resisting installation

Other fire resisting installation methods

Other methods of creating a fire resisting installation are possible for all Amina loudspeakers.

These include pre-building an appropriate plasterboard lined compartment at the rear of the loudspeaker/BackboxCV or using commercially available fire hood type products.

Accessories

Subwoofers

ALF80

150W passive subwoofer with unique adjustable port design allowing the product to be installed within joinery, behind kick boards or within ceilings or other voids. Highly discrete, powerful and deep bass response is achieved with only a small opening for the port required within the room.

ALF120

Amina have developed an astonishing subwoofer technology dubbed 'distributed transmission line' (DTL), which allows the design of a subwoofer thin enough to be built into a stud wall, venting through a simple slot in the skirting board, to create an impressively low 27Hz audio output at 111dB loudness using only 50W of power.

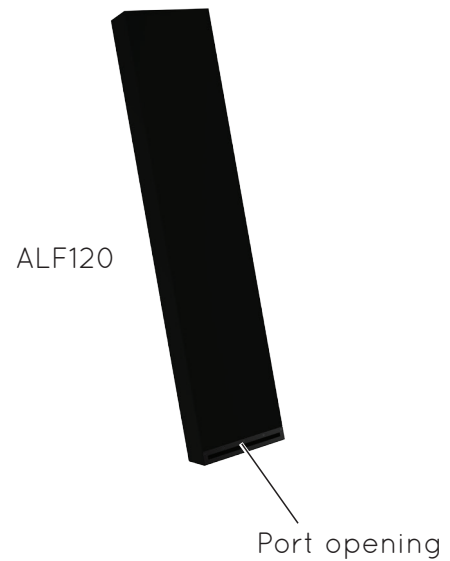

Troubleshooting

Thorough testing of the loudspeakers should be carried out both prior to and after plastering to avoid time consuming repairs or modifications at a later stage. Should you encounter any problems at either of the test stages the following guide is designed to help determine possible problem areas.



CAUTION:

Do not use a battery or DC voltage supply to check continuity or phase check as there is no forward or backward movement of the panel.

DC voltage can damage the speaker.

Advice for testing

- When testing always use a basic sound system (amp, source, loudspeakers) to eliminate the possibility of faults with other, more sophisticated components, such as control systems.
- Test at low and medium volumes and be careful not to exceed the specific speaker model's recommended power. Using tone sweeps or music as test material, listen for distortion, buzzing or rattles at appropriate levels. Using test discs or music, confirm that all channels are in-phase.
- Ideally professional test equipment should be used to record a full frequency response of the loudspeaker before and after plastering.

No or low sound output

- Check continuity of all cables.
- Check that all cables and connections are made correctly, are intact and that all channels have the correct polarity (+ to + and - to - from amp to speaker).
- Using an impedance meter, check the nominal impedance of the speaker (APU must not be connected) both at the loudspeaker and the amp end of the cable. Do these measurements match each other? (Allowing for the small impedance increase of less than 1 ohm along the wire length) Do they match the stated nominal impedance on the loudspeakers specification label? If the nominal impedance, measured at the loudspeaker is dramatically different to the product's stated impedance, a speaker driver may be open circuited or short circuited. If so, the product may need to be returned to Amina for repair or replacement.
- If the nominal impedance at the end of the cable is very different to the impedance at the speaker, check your cables. Cuts or nicks in the cable along its length can dramatically increase impedance or create a short circuit, dramatically lowering the impedance.

Troubleshooting

Distortion, buzzing or rattles at modest volumes

- Try to identify the location of the buzz or rattle. It may be caused by a loose screw or other mechanical object. Check the wall or ceiling and speaker assembly and ensure screws and fixings are tight.
- If the rattle persists, remove the speaker from the wall and check your wiring to the product. Ensure that wires, with the speaker in the final location, are not resting against the speaker or backbox (if used), causing vibrations.
- With no audio signal applied, lightly push the speaker face in and out at its centre. Listen carefully for rubbing on the driver, which may sound like scratching. This may indicate the speaker has been over driven and subsequently damaged. The speaker will need to be sent to Amina for repair or replacement.

Very low output after speaker passes electrical tests

- With no audio signal applied, lightly push the panel in and out at its center. Listen carefully for rubbing voice coils on the driver, which may sound like scratching. This may indicate the speaker has been over driven and subsequently damaged. The speaker will need to be sent to Amina for repair.

Distortion at higher volume levels

- Diffuse source panel loudspeakers of this type have an extremely fast response, articulating the signal from your audio system very accurately. Take your system back to the bare minimum (amplifier, source and loudspeakers) to eliminate distortions introduced by other components.
- When using your amplifier at maximum power levels, or if the input of your amplifier is being overloaded, the signal level may be 'clipping'. With some conventional loudspeakers this may not be evident, but with a diffuse source panel speaker you are much more likely to hear the distortion. Consider adjusting or upgrading your system.



NOTE: Excessive pressure on the front of the speaker panel may cause cracking in the plaster which may need to be filled.

Specifications

Amina Edge series - Plaster up to products

Model number	Edge5i	Edge7i
Dimensions	450mm x 345mm x 38mm (17 ³ / ₄ " x 13 ⁵ / ₈ " x 1 ¹ / ₂ "	450mm x 345mm x 33mm (17 ³ / ₄ " x 13 ⁵ / ₈ " x 1 ¹ / ₈ "
Weight	1.30kg (2lbs 10oz)	1.80kg (3lbs 15oz)
Nominal impedance	4Ω	4Ω
Frequency response	55Hz to 26kHz	50Hz to 27kHz
Sensitivity (@ 1m/2.83Vrms)	90dB	90dB
In-line protection unit (single channel)	APUi50C_2	APUi70C_2
In-line protection unit (multi-channel)	APU-RS8iC / APU-RS16iC	
Fixing requirement	Amina BackboxCV345 / Basic fixing kit	
Power handling (continuous)	50W	75W
Power handling (peak)	100W	150W
Operating temperature range	16°C - 40°C (61°F - 104°F)	
Manufacturer warranty	10 years (residential systems), 5 years (commercial systems)	

Model number	Edge3
Dimensions	400mm x 300mm x 31mm (15 ³ / ₄ " x 11 ⁷ / ₈ " x 1 ¹ / ₄ "
Weight	0.97kg (2lbs 2oz)
Nominal impedance	8 ohm
Frequency response	90Hz-24kHz
Sensitivity (@ 1m/2.83Vrms)	86dB
In-line protection unit (single channel)	APUi30C
In-line protection unit (multi-channel)	APU-RS8iC / APU-RS16iC
Fixing requirement	Amina BackboxCV300 / Basic fixing kit
Power handling (continuous)	30W
Power handling (peak)	60W
Operating temperature range	16°C - 40°C (61°F - 104°F)
Manufacturer warranty	10 years (residential systems), 5 years (commercial systems)

Warranty information

Limited Warranty:

Amina loudspeakers are designed to operate reliably for many years. Correctly installed in accordance with these instructions, Amina warrants the loudspeakers against defective materials and manufacturing workmanship for a period of ten years in residential and five years in commercial applications.

At the end of the speaker's useful life and in compliance with the European directive on waste electrical and electronic equipment (WEEE), this product is to be returned to your supplier, or directly to Amina for recycling. If you have any questions please contact Amina Technologies Ltd.

* Please refer to our full warranty statement for details, available on our website, or alternatively contact us via email.



Important Note: This product has not been tested to European Construction Products Regulations EN 54-24 and therefore must not be used in voice evacuation systems located within the European Union.

Copyright information

This document is Copyright of Amina Technologies Ltd, 2019

Gyproc-Joint-Filler is a registered trademark of British Gypsum Ltd

Amina is a registered trademark of Amina Technologies Ltd

Amina Edge is a registered trademark of Amina Technologies Ltd

Amina Sound is a registered trademark of Amina Technologies Ltd

Astroflame is a registered trademark of Astroflame (Fireseals) Ltd.

Toupret is a registered trademark of Toupret S.A., France.

Contact information

Amina Technologies Ltd

Cirrus House, Glebe Road, Huntingdon

Cambridge, PE29 7DL, UK

T: +44 (0)1480 354390

E: info@aminasound.com - enquiries

E: support@aminasound.com - expert advice

E: sales@aminasound.com - sales team

W: www.aminasound.com

Registered in the UK, company no: 3656822

amina®

THE INVISIBLE SPEAKER CO.

Audio for very smart homes®

Amina Technologies Ltd
Cirrus House, Glebe Road
Huntingdon, Cambs, PE29 7DL England
T: +44 (0)1480 354390
W: www.aminasound.com / E: info@aminasound.com
Copyright 2019

Edge with BackboxCV V3.5
