

# Gefen TOOLBOX

## HD Pattern Signal Generator

GTB-HD-SIGGEN

User Manual



[www.gefentoolbox.com](http://www.gefentoolbox.com)



## ASKING FOR ASSISTANCE

---

### Technical Support:

Telephone (818) 772-9100  
(800) 545-6900

Fax (818) 772-9120

### Technical Support Hours:

8:00 AM to 5:00 PM Monday through Friday, Pacific Time

### Write To:

Gefen, LLC  
c/o Customer Service  
20600 Nordhoff St  
Chatsworth, CA 91311

[www.gefentoolbox.com](http://www.gefentoolbox.com)  
[support@gefentoolbox.com](mailto:support@gefentoolbox.com)

### Notice

Gefen, LLC reserves the right to make changes in the hardware, packaging and any accompanying documentation without prior written notice.

**HDMI**, the **HDMI** logo, and **High-Definition Multimedia Interface** are trademarks or registered trademarks of HDMI Licensing in the United States and other countries.

**HD Pattern Signal Generator** is a trademark of Gefen, LLC

Windows is a registered trademark of Microsoft Corporation in the United States and other countries.

© 2012 Gefen, LLC. All rights reserved.  
All trademarks are the property of their respective owners.

# CONTENTS

---

- 1 Introduction
- 2 Operation Notes
- 3 Features
- 4 Top Panel Layout
- 5 Top Panel Descriptions
- 6 Back Panel Layout
- 7 Back Panel Descriptions
- 8 Control Panel Layout
- 9 Control Panel Descriptions
- 11 Connecting The GefenToolBox HD Pattern Signal Generator
  - 11 Wiring Diagram
- 12 IR Remote Description
- 14 HD Pattern Signal Generator Remote Installation
- 15 Operating The GefenToolBox HD Pattern Signal Generator
  - 15 Display Window
  - 15 Timing Buttons
  - 16 Pattern Buttons
  - 16 Resetting the HD Pattern Signal Generator
- 17 Pattern Summary
  - 17 Purity
  - 18 Color Settings
  - 20 Color Bars
  - 20 Gray Scale
  - 21 Black White Line
  - 22 Pluge
  - 23 Grid
  - 23 Gradient
  - 24 Circles
  - 24 EDID
  - 28 Audio
  - 32 HDCP
  - 34 Motion
  - 34 Data Analysis
  - 37 System Setup
- 39 Timing Summary
- 41 HD Pattern Signal Generator Software
  - 41 Installing the Software
  - 44 Connecting the RS-232 cable
  - 45 Running the HD Pattern Signal Generator Software
  - 47 Selecting the Timing

# CONTENTS

---

48	Selecting the Pattern
49	Unique Patterns
49	Color Setting Pattern
51	Motion Pattern
53	Favorite Timing
54	Favorite Pattern
55	EDID Read / Write
57	Translating EDID (Verbose Form)
61	Generating the EDID Checksum
64	Saving an EDID to a File
67	Clearing the EDID from Memory
68	Loading an EDID from a File
70	Comparing EDID Data
72	Writing EDID to a Sink
73	Erasing the EDID of a Sink
74	Opening Recent EDID Files
75	Autorun Configuration
76	Panel Control
77	Getting the Hardware and Firmware Version
78	RS-232 Control
79	RS-232 Commands
81	Notes
82	Wall Mounting Instructions
83	Specifications
84	Warranty



# INTRODUCTION

---

Congratulations on your purchase of the GefenToolBox HD Pattern Signal Generator. Your complete satisfaction is very important to us.

## About Gefen

Gefen delivers innovative, progressive computer and electronics add-on solutions that harness integration, extension, distribution, and conversion technologies. Gefen's reliable, plug-and-play products supplement cross-platform computer systems, professional audio/video environments, and HDTV systems of all sizes, with hard-working solutions that are easy to implement and simple to operate.

## GefenToolBox

The GefenToolBox line offers portable and easy-to-install solutions for common A/V system integration setups using HDMI connectivity. GefenToolBox products are wall-mountable and small in size. GefenToolBox products are easily transported in the field and are ready for immediate and simple installations in working environments.

## The GefenToolBox HD Pattern Signal Generator

The GefenToolbox HD Pattern Signal Generator is the most advanced testing device for your audio and video equipment. 39 built-in timings, 41 patterns, and four (4) data analysis patterns provide over a thousand testing combinations for both analog and digital devices. The front panel LCD screen provides easy viewing of functions and features for each timing / pattern. This device can be conveniently controlled via the front panel buttons, the IR remote or the downloadable software from the Gefen Web site. In addition to its portability, this signal generator is wall-mountable and field-upgradeable.

## How It Works

Connect the HDMI output port of the GefenToolbox HD Pattern Signal Generator to your HDTV display. Power-on all equipment. The front panel LCD will display all features and options of the active timing and pattern. You can feed digital or analog audio into the generator's rear panel and hear multi-channel digital audio or use the built-in sine wave test tone.

## OPERATION NOTES

---

### **READ THESE NOTES BEFORE INSTALLING OR OPERATING THE GEFENTOOLBOX HD PATTERN SIGNAL GENERATOR**

- The GefenToolBox HD Pattern Signal Generator can be controlled using a software application and RS-232. Download this application from the Gefen Web site at: <http://www.gefen.com/kvm/support/download.jsp>



# FEATURES

---

## Features

- Multi-format video output for SD and HD video up to 1080p
- PC/HD resolutions up to UXGA / WUXGA (1920 x 1200)
- 39 timings, 41 patterns, and 4 data analysis patterns
- Supports RGB 4:4:4, YCbCr 4:4:4, and YCbCr 4:4:2 color spaces
- Supports NTSC and PAL frame rates
- 2 CH, 5.1 CH, and 7.1 CH LPCM internal sine wave generator
- RS-232 control via the downloadable software from the Gefen Web site.
- Small form factor; easy to transport
- Supports HD timings for VGA output
- HDCP Pattern
- Supports reading and copying EDID functionality.
- User Friendly Interface - LCD Display, LED indicators and Software.
- Deep Color support up to 12-bit
- HDMI 1.3 and DVI 1.0 Compliant
- HDCP Compliant

## Sample Applications

- Apparatus Testing and Troubleshooting
- Equipment Adjustment
- EDID checking
- Source / Sink definition
- HDCP Verification

## Package Includes

- (1) GefenToolBox HD Pattern Signal Generator
- (1) 6ft. HDMI cable (M-M)
- (1) IR Remote
- (1) 5 V DC Power Supply
- (1) User Manual

# TOP PANEL LAYOUT

## Top Panel



# TOP PANEL DESCRIPTIONS

---

## Top Panel

- 1 LCD Display**  
Displays pattern and timing information in addition to other functions used by the Signal Generator.
- 2 IR Window**  
Receives signals from the IR Remote Control unit.
- 3 Control Panel**  
See pages 8 - 10 for detailed information on the Control Panel.

# BACK PANEL LAYOUT

## Back Panel

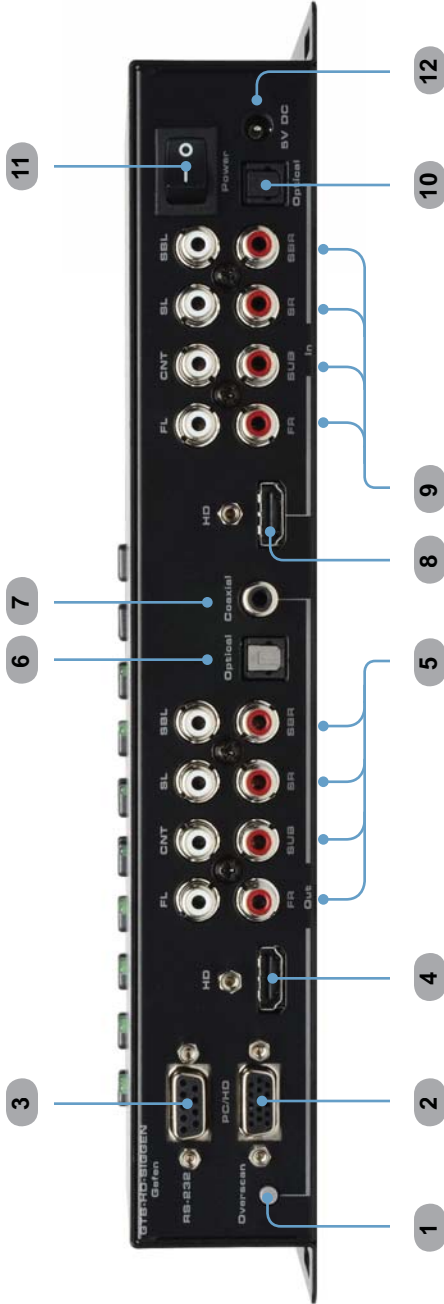

# BACK PANEL DESCRIPTIONS

---

## Back Panel

### **1 Overscan Button**

By default, the GefenToolBox HD Pattern Signal Generator is set to underscan mode. If the video signal does not fill the entire display, press this button once to switch to overscan mode. Press the Overscan button a second time to return to underscan mode.

### **2 VGA Output**

Connect a VGA monitor to this port.

### **3 RS-232 Serial Port**

Connect an RS-232 cable from this port to the computer running the HD Pattern Signal Generator software.

### **4 HD Out**

Connect an HDTV display to this HDMI port. DVI displays can be connected using an HDMI to DVI cable or adapter.

### **5 Analog Audio Outputs**

8 RCA type audio outputs (FL, FR, C, SUB, SL, SR, SSL, and SSR) are available for connection to a separate amplifier. Up to 6 discrete channels can be utilized.

### **6 TosLink Output Connector**

Connect an optical cable from this output to an amplifier or other audio output device.

### **7 S/PDIF Output Connector**

Connect a coax cable from this output to an amplifier or other audio output device.

### **8 HD In**

Used to connect a Hi-Def source to the Signal Generator using an HDMI cable. DVI displays can be connected using an HDMI to DVI cable or adapter.

### **9 Analog Audio Inputs**

8 RCA type audio outputs (FL, FR, C, SUB, SL, SR, SSL, and SSR) are available for connection from a source device.

### **10 TosLink Input Connector**

Connect an optical cable from the audio source device to this connector.

### **11 Power Switch**

Turns the Signal Generator power ON or OFF.

### **12 5 V DC Power Connector**

Connect the included 5 V DC power supply to this connector.

# CONTROL PANEL LAYOUT

## Control Panel

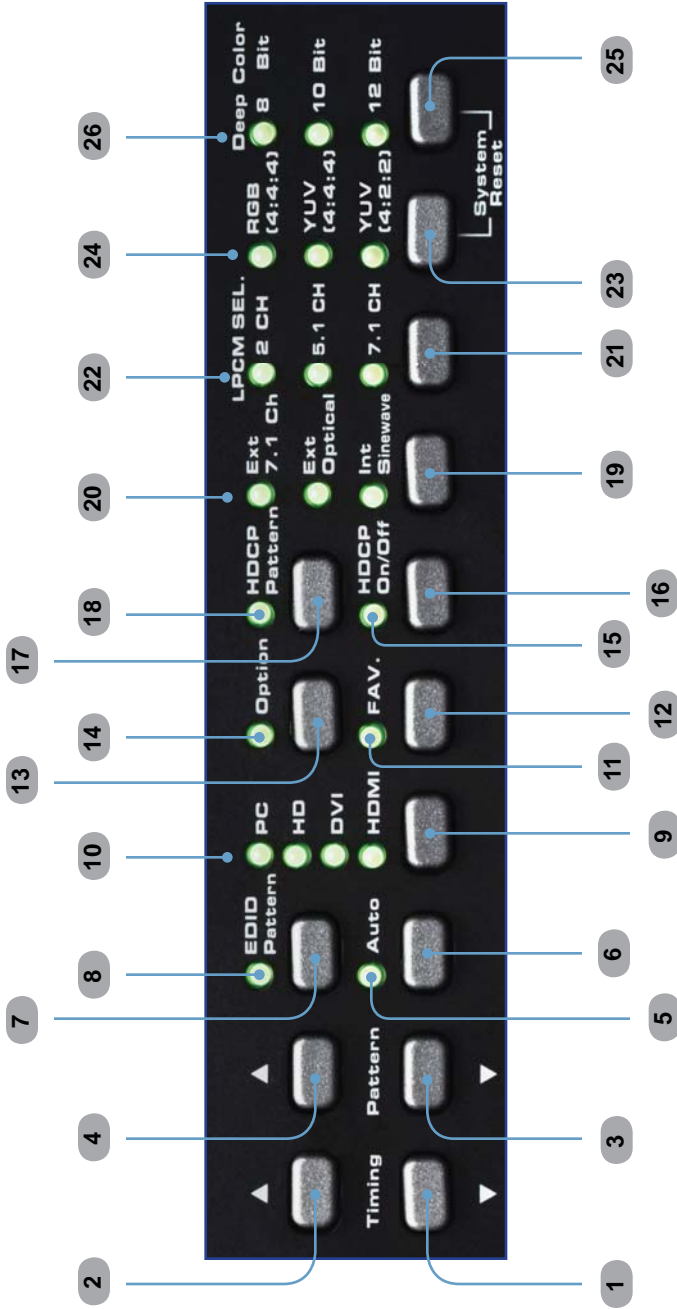

# CONTROL PANEL DESCRIPTIONS

---

## Control Panel

- 1 Timing (Down)**  
Cycles backward through the list of timings.
- 2 Timing (Up)**  
Cycles forward through the list of timings.
- 3 Pattern (Down)**  
Cycles backward through the list of patterns.
- 4 Pattern (Up)**  
Cycles forward through the list of patterns.
- 5 Auto Indicator**  
This LED will glow bright green when the Signal Generator is placed in Auto mode.
- 6 Auto**  
Automatically cycles through a specified list of timing / pattern sets. The Autorun Demonstration mode is configured through the HD Pattern Signal Generator software. See page 72 for details.
- 7 EDID Pattern**  
Press this button to jump directly to the EDID Pattern (P38). See page 21 for more information on using the EDID Pattern.
- 8 EDID Pattern Indicator**  
This LED will glow bright green when the Signal Generator is placed in EDID mode.
- 9 Output Signal Button**  
Selects between PC / HD (VGA), DVI, or HDMI signal types. Consecutively press this button to cycle through each of the signal types.
- 10 Output Signal Indicators**  
These LED indicators will glow bright green to indicate the current video output mode (PC, HD, DVI, or HDMI).
- 11 Fav. Button**  
Configures the generator to show only the patterns selected using the HD Pattern Signal Generator software (see page 51 for details). This button is also used to change parameters when using certain patterns.
- 12 Fav. Indicator**  
This LED will glow bright green when the [Fav] button is pressed.
- 13 Option Button**  
The option button provides access to sub-functions within certain patterns.

## CONTROL PANEL DESCRIPTIONS

---

### **14 Option Indicator**

This LED will glow bright green when the Signal Generator is in Option mode.

### **15 HDCP On / Off Indicator**

This LED will glow bright green when HDCP content is being sent from the Signal Generator.

### **16 HDCP Button**

Enables / disables HDCP on the output. See page 29 for more information on using HDCP.

### **17 HDCP Pattern Button**

Press this button to jump directly to the HDCP Pattern (P40).

### **18 HDCP Pattern Indicator**

This LED will glow bright green when the HDCP Pattern (P40) is enabled.

### **19 Audio Selection Button**

Pressing this button consecutively will cycle through the different audio output options (see page 25 for details).

### **20 Audio Selection Indicator**

These LED indicators will glow bright green to indicate the current audio output mode.

### **21 Audio Channel Button**

Pressing this button consecutively will cycle through the different output audio channels (see page 25 for details).

### **22 Audio Channel Indicator**

These LED indicators will glow bright green to indicate the current audio channel selection.

### **23 Color Space Selection Button**

Pressing this button consecutively will cycle through the available output color spaces.

### **24 Color Space Selection Indicator**

These LED indicators will glow bright green to indicate the current color space.

### **25 Bit Depth Selection Button**

Selects between 8-bit, 10-bit, or 12-bit color.

### **26 Bit Depth Indicator**

These LED indicators will glow bright green to indicate the current color bit depth selection on the output.



# CONNECTING THE HD PATTERN SIGNAL GENERATOR

## How to Connect the GefenToolBox HD Pattern Signal Generator

1. Connect an HDMI cable from the GefenToolBox HD Pattern Signal Generator to the HDTV Display.
2. Connect an optional external audio source to the HD Pattern Signal Generator using an optical cable or RCA cables.
3. Connect the included 5V DC power supply to the power receptacle on the HD Pattern Signal Generator and connect the power cord to an available electrical outlet.
4. Turn on the HDTV display first, then turn on the HD Pattern Signal Generator.

## Wiring Diagram for the GefenToolbox HD Pattern Signal Generator

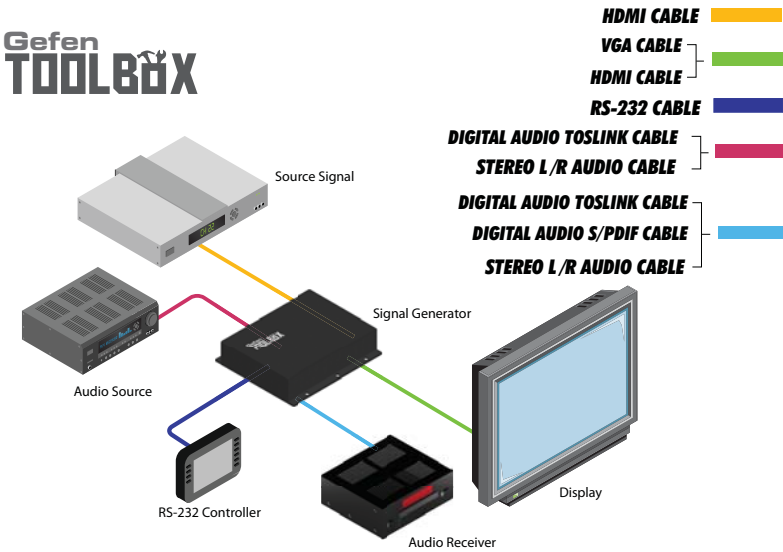

**GTB-HD-SIGGEN**

# IR REMOTE CONTROL UNIT

## IR Remote Layout and Descriptions (RMT-HD-SIGGEN)

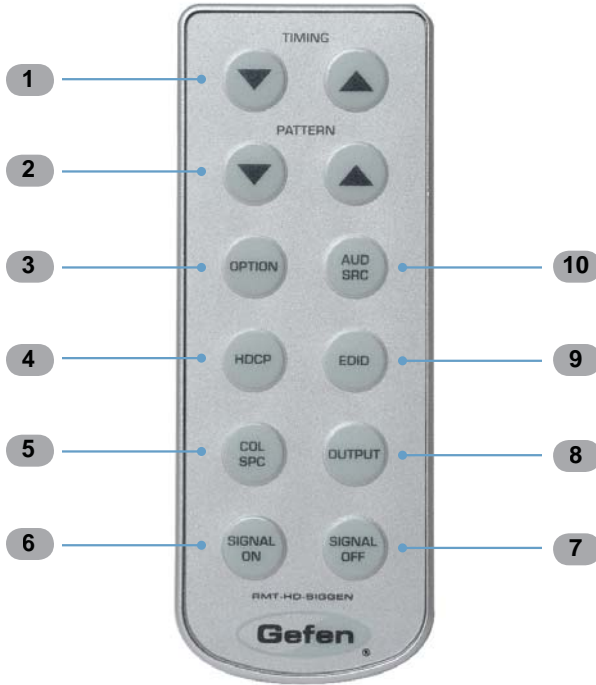

- 1 ▼ / ▲ (Timing)**  
Cycles forward (▲) and backward (▼) through the list of timings.
- 2 ▼ / ▲ (Pattern)**  
Cycles forward (▲) and backward (▼) through the list of patterns.
- 3 Option**  
The Option button provides access to sub-functions within certain patterns.
- 4 HDCP**  
Enables / disables HDCP on the output. See page 29 for more information on using HDCP.
- 5 Col Spc**  
Pressing this button consecutively will cycle through the available output color spaces.

## IR REMOTE CONTROL UNIT

---

**6 Signal On**

Turns the signal ON after it has been turned off (A/V mute) using the Signal Off button.

**7 Signal Off**

Turns the signal OFF (A/V mute).

**8 Output**

Selects between PC / HD (VGA), DVI, or HDMI signal types. Consecutively press this button to cycle through each of the signal types.

**9 EDID**

Press this button to jump directly to the EDID Pattern (P38). See page 21 for more information on using the EDID Pattern.

**10 Aud Src**

Pressing this button consecutively will cycle through the different audio output options (see page 25 for details).

## IR REMOTE CONTROL UNIT

---

### Installing the Battery

1. Hold the IR remote control unit facing down and gently pull the battery tab with your thumb to reveal the battery slot.
2. Insert the included battery into the battery slot. The battery slot indicates that the positive (+) side of the battery must be facing up as shown below:

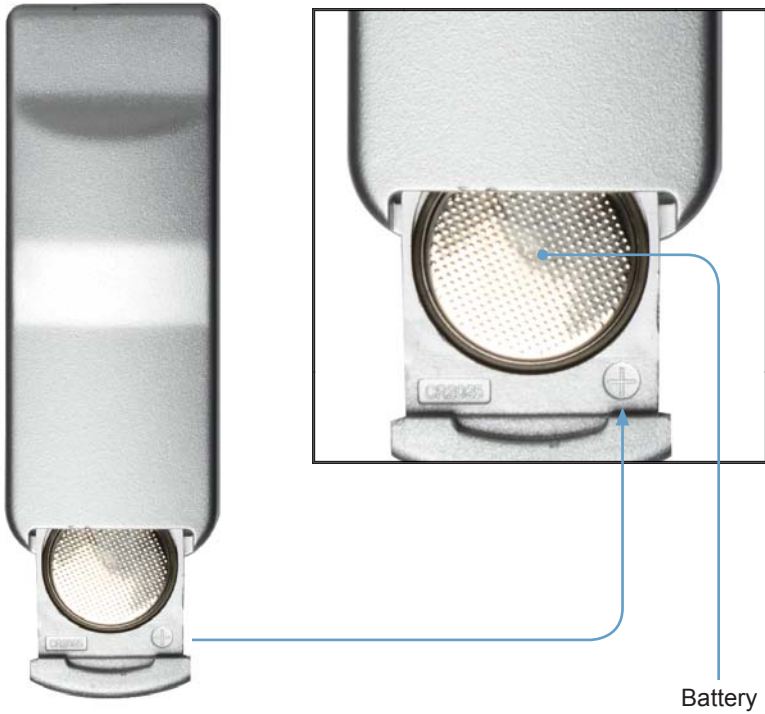

3. Close the battery slot by sliding it closed.

# OPERATING THE HD PATTERN SIGNAL GENERATOR

## Display Window

The **Display Window** of the GefenToolBox HD Pattern Signal Generator is a 16-character, 2-line display. This display will show the currently selected timing and pattern on the output. In addition, this display is also used for providing information or messages about the connected devices. When the unit is powered on, a screen similar to the following will be displayed:

Currently selected timing

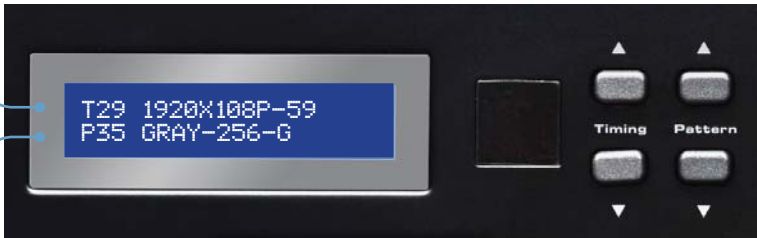

Currently selected pattern

## Timing Buttons

To change the timing, use the ▲ and ▼ Timing buttons. The ▲ button will move forward through the timings. Use the ▼ button will move backward through the timings. See pages 36 - 37 for a list of supported timings.

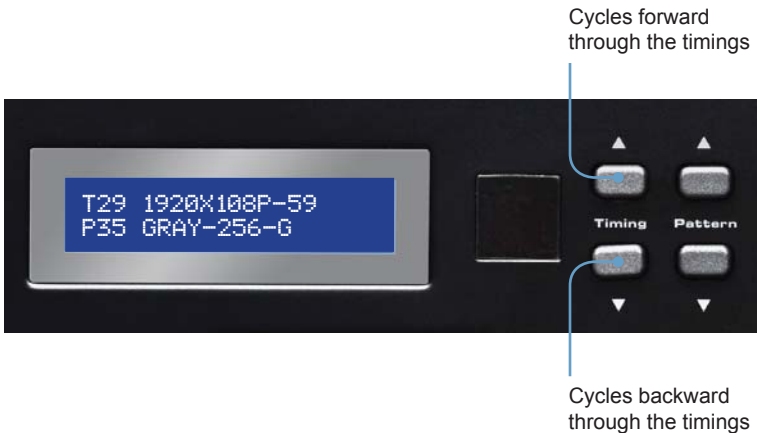

# OPERATING THE HD PATTERN SIGNAL GENERATOR

## Pattern Buttons

To change the pattern, use the ▲ and ▼ Pattern buttons. The ▲ button will move forward through the patterns (see the pages 14 - 35 for a list of available patterns). Use the ▼ button to move backward through the patterns.



**TIP:** Press and hold the ▲ or ▼ buttons to rapidly cycle through either the timings or patterns.

## Resetting the HD Pattern Signal Generator

To reset the HD Pattern Signal Generator to factory default settings, simultaneously hold down the Color Space Selection button and the Bit Depth Selection button. During the reset sequence, the LCD display will show the message: System Reset

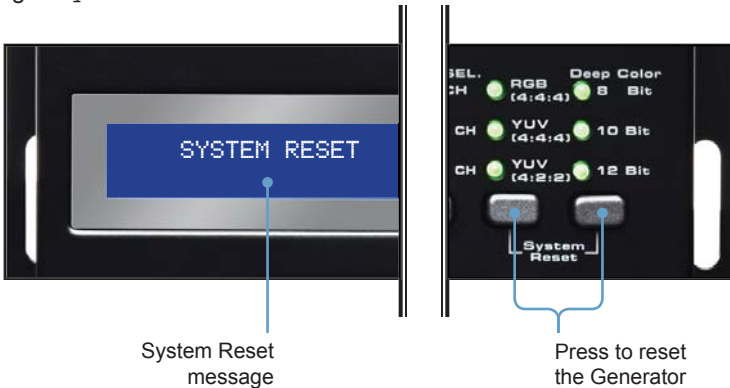

















# PATTERN SUMMARY

---

## Purity

### Pattern 01 - Pattern 08 (P01 - P08)

Press the [OPTION] button to switch between Full Screen and Windowed format.

P01	White		
P02	Blue		
P03	Red		
P04	Magenta		
P05	Green		
P06	Cyan		
P07	Yellow		
P08	Black		

Red (P03) and Green (P05) are often used to check color purity. When using the Red pattern, no other color should be present on the screen. If the Red pattern appears tinted, then this is an indication that the color purity should be adjusted. The Red pattern can also be used to ensure that there is no interference between the sound and the chroma carrier, in addition to adjusting the long play delay level to minimum flicker.

## PATTERN SUMMARY

Green (P05) provides a color purity check for display devices that use three in-line guns. The in-line configuration defines guns which are positioned horizontally with the green gun located in the center (R-G-B).

Blue (P02) is a complementary color. This pattern is frequently used to test color performance.

### Color Settings

#### Pattern 09 - Pattern 13 (P09 - P13)

Press the [OPTION] button to enter the pattern options. Use the Pattern [UP] and [DOWN] buttons to adjust the color level. Press the [FAV] button to switch between full and limited color range.

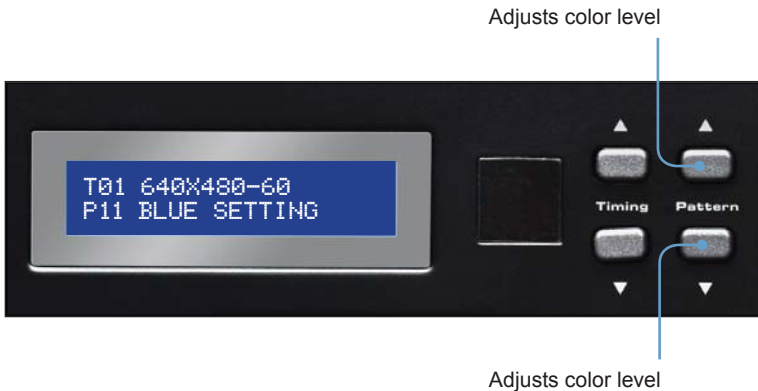



## PATTERN SUMMARY

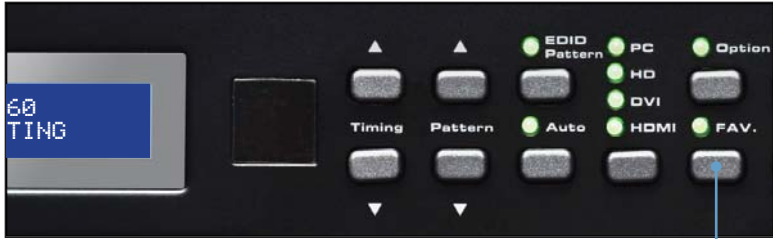

Switch between full and limited color range

When using Pattern 09 - Pattern 12, a black screen will be displayed, first. Use the [OPTION] to enable to the pattern. The Blue Pattern (P11) is illustrated below:

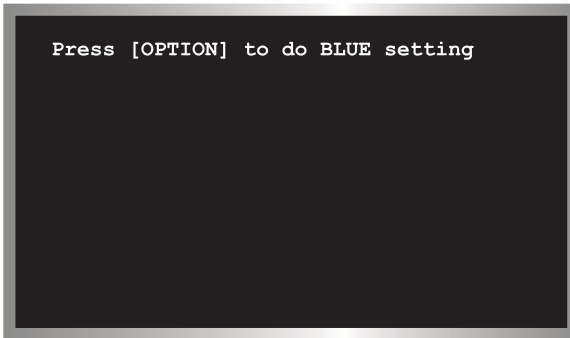

The BLUE Setting pattern (P11) with blue level at 203 and set to the Full color range setting using the [FAV.] button:

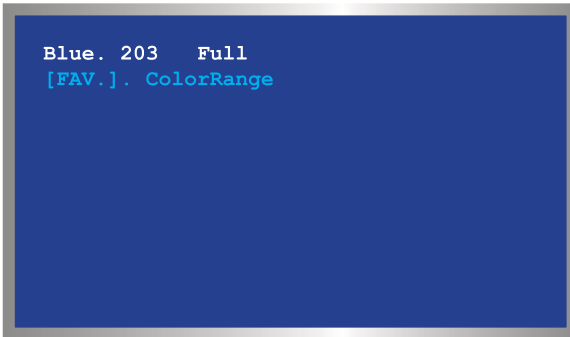

Pattern 13 (P13) will appear as a white screen and can only be controlled using RS-232. See page 46 for more information.





# PATTERN SUMMARY

---

## Color Bars

### Pattern 14 - Pattern 17 (P14 - P17)







There are four different color bar patterns. Use the [OPTION] button on Pattern 14 (P14) and Pattern 16 (P16) to switch between 75 IRE (Option LED indicator OFF) and 100 IRE (Option LED indicator ON).

P14	Color Bar	
P15	SMPTE Color Bar	
P16	Split Bar	
P17	RGB Delay	

## Gray Scale

### Pattern 18 - Pattern 22 (P18 - P22)

Gray scale patterns can be used to locate faulty linearity of the video amplifier or gray scale settings. Use the [OPTION] button on Gray-11 (P19) to alternate between the two patterns. Option LED indicator OFF = Vertical Pattern, ON = Cross Pattern.

P18	Gray-8		
P19	Gray-11		
P20	Gray-32		
P21	Gray-256		
P22	H.Gray-11		

# PATTERN SUMMARY





---

## Black White Line

### Pattern 23 -Pattern 26 (P23 - P26)

The vertical pattern serves as a test for the horizontal bandwidth and phase behavior of a color monitor. This pattern can also be used to verify the video amplifier and color temperature.

The horizontal pattern can check the vertical bandwidth and phase behavior, in addition to verifying the video amplifier integrity and color temperature.

P23	V Line ONOFF	
P24	H Line ONOFF	
P25	MULTI-BURST	
P26	Dual Needle	

# PATTERN SUMMARY





---

## Pluge

### Pattern 27 - Pattern 31 (P27 - P31)

Pluge (Picture line up) patterns are used to perform accurate and consistent line-up of the output signal (video). The concept behind Pluge patterns is to adjust the brightness control so that the first bar is invisible, while the second bar remains visible.

Use the [OPTION] button on PLUGE-5 (P31) to cycle through each of the Pluge variations.

P27	PLUGE-1	
P28	PLUGE-2	
P29	PLUGE-3	
P30	PLUGE-4	
P31	PLUGE-5	

By default, Pattern 31 (P31) is set to the first pluge pattern. During this state, the Option LED indicator will be OFF.

Press the [OPTION] button to display the second Pluge-5 variation pattern. The Option LED indicator will glow bright green.

Press the [OPTION] button a third time to display the third Pluge-5 variation pattern. The Option LED indicator will glow bright green.

Pressing the [OPTION] button a fourth time will display the original Pluge-5 pattern. The Option LED indicator will turn OFF.

# PATTERN SUMMARY

---

## Grid

### Pattern 32 - Pattern 33 (P32 - P33)

Grid and cross patch patterns are mainly used for detecting corner convergence (“pin cushions”).

P32

GRID



P33

Cross Hatch

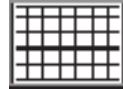
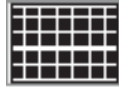

Press the [OPTION] button on Pattern 33 (P33) to toggle between the black/white (Option LED indicator is OFF) and white/black (Option LED indicator is ON) cross hatch patterns.

## Gradient

### Pattern 34 - Pattern 36 (P34 - P36)

Gradient patterns are used to detect linearity faults in the video amplifier. Non-linearities will usually result in color level compression.

P34

GRAY-256-R



P35

GRAY-256-G



P36

GRAY-256-B



# PATTERN SUMMARY

## Circles

### Pattern 37 (P37)

Produces a pattern with large circles on the screen. This pattern is primarily used for checking the overall geometry and linearity of the display.

P37

CIRCLES



## EDID

### Pattern 38 (P38)

Displays the EDID pattern screen. This pattern is used to analyze the EDID data of the connected sink (display, A/V receiver, etc).

P38

EDID Analysis



**TIP:** The EDID pattern (P38) can also be directly accessed by pressing the [EDID] button on the top panel.

Jump directly to the EDID pattern (P38) from any pattern



The EDID pattern supports up to two (2) blocks (Block0 and Block1).

## PATTERN SUMMARY

---

When the EDID pattern is selected, the display will appear as follows:

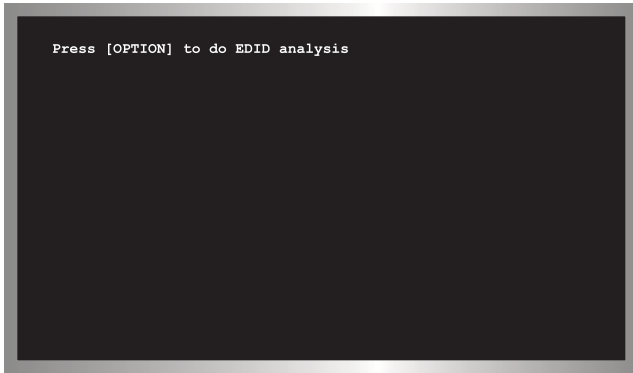

To use the EDID pattern, follow the instructions below:

- 1 Press the [OPTION] button.
- 2 The EDID Analysis Menu will be displayed. The first line of the menu will be highlighted in blue.

EDID Source Select  
is highlighted in blue.

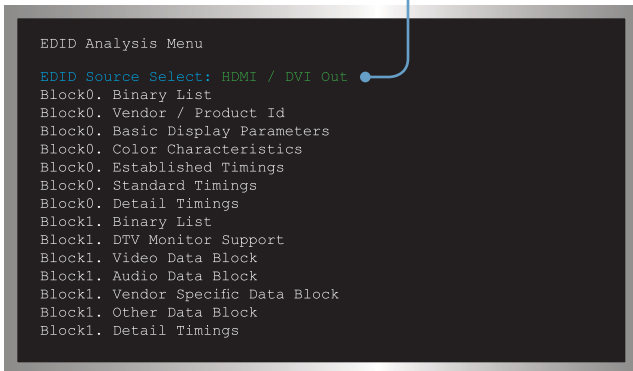

- 3 Press the [OPTION] button to select between HDMI / DVI Out, HDMI / DVI In, or VGA PC / HD Out.

## PATTERN SUMMARY

---

- **HDMI / DVI Out**  
Reads the EDID of the sink (display, A/V receiver, etc) connected to the HD Pattern Signal Generator.
  - **HDMI / DVI In**  
Reads the built-in EDID of the HD Pattern Signal Generator.
  - **VGA PC / HD Out**  
Reads the EDID of the display connected to the VGA port of the HD Pattern Signal Generator.
- 4 In this example, the HDMI / DVI Out option will be used. An HDMI cable is connected between the sink and the HD Out port of the HD Pattern Signal Generator. Any of the three options (mentioned above) could be used, depending upon the application.
  - 5 Press the ▼ Pattern button twice to scroll down to the Block0. Vendor / Product Id option.

Block0. Vendor / Product Id is highlighted in blue.

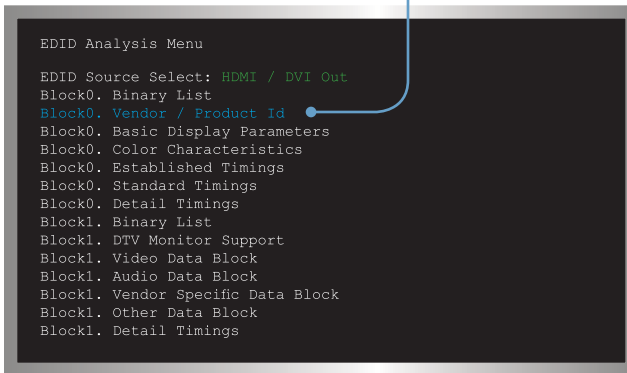

```
EDID Analysis Menu
EDID Source Select: HDMI / DVI Out
Block0. Binary List
Block0. Vendor / Product Id
Block0. Basic Display Parameters
Block0. Color Characteristics
Block0. Established Timings
Block0. Standard Timings
Block0. Detail Timings
Block1. Binary List
Block1. DTV Monitor Support
Block1. Video Data Block
Block1. Audio Data Block
Block1. Vendor Specific Data Block
Block1. Other Data Block
Block1. Detail Timings
```

- 6 Press the [OPTION] button on the top panel to display this section of the EDID data structure.



## PATTERN SUMMARY

---

The HD Pattern Signal Generator will display the Vendor / Product Id EDID information on the screen.

Your Vendor / Product Id EDID information will most likely differ from the example below:

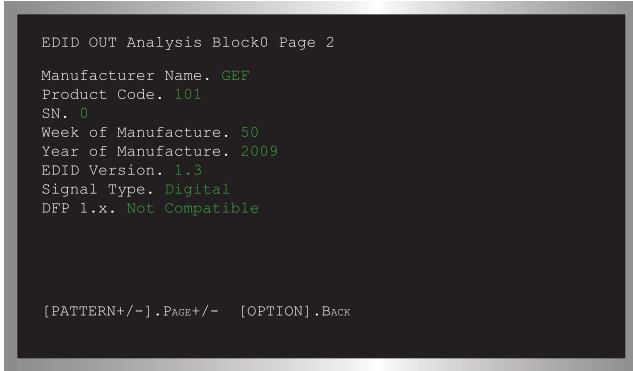

```
EDID OUT Analysis Block0 Page 2
Manufacturer Name. GEF
Product Code. 101
SN. 0
Week of Manufacture. 50
Year of Manufacture. 2009
EDID Version. 1.3
Signal Type. Digital
DFP 1.x. Not Compatible

[PATTERN+/-].PAGE+/- [OPTION].BACK
```

In this example, the HD Pattern Signal Generator reported the following EDID information for the Vendor / Product Id in Block 0:

```
EDID OUT Analysis Block0 Page 2
Manufacturer Name. GEF
Product Code. 101
SN. 0
Week of Manufacture. 50
Year of Manufacture. 2009
EDID Version. 1.3
Signal Type. Digital
DFP 1.x. Not Compatible
```

- 7 Press the [OPTION] button to return to the EDID Analysis Menu or press the ▲ or ▼ Pattern buttons to display each section of the EDID data structure, without having to return to the EDID Analysis Menu.
- 8 To exit the EDID pattern, return to the EDID Analysis Menu (press the [OPTION] button if required) to return to the EDID Analysis Menu, then press the [EDID] button on the top panel. Press the ▲ or ▼ Pattern buttons to select another pattern.

# PATTERN SUMMARY

## Audio

### Pattern 39 (P39)

This pattern displays the audio information of the connected source device, such as the number of audio channels, sampling rate, and I<sup>2</sup>S (Intergrated Interchip Sound) bus data.

P39

AUDIO



The table below provides a listing of the audio input and audio output combinations when using the Audio Pattern (P39).

		Output		
		Analog 7.1 Ch	Optical / Coax	HDMI
Input	Ext. 7.1 Ch	Bypass	LPCM 2CH @ 48 kHz	Ext. 7.1 Ch
	Ext. Optical	2 CH	Bypass	Bypass
	Int. Sinewave	2CH, 6CH, 8CH	LPCM 2 CH @ 48 kHz	Ext. Optical

### External 7.1 Channel Audio Input

In the example below, the Audio Pattern is shown using the external 7.1 channel audio input.

Current Audio input selection.

```
Audio Pattern
INPUT: Ext. 7.1CH
_____
      OUTPUT
Analog 7.1CH: Bypass
OPTICAL/COAX: LPCM 2CH 48KHz
HDMI: LPCM 2/6CH 48KHz

[2CH/5.1CH]. HDMI-OUT Audio Channels
[EXT. 7.1CH/OPTICAL/SINEWAVE]. Audio Source
```

## PATTERN SUMMARY

In the example above, the Audio Pattern is shown using the external 7.1 channel audio input. The Audio Input Selection button is used to change the audio input type.



Audio Input Selection button

Text that is highlighted in yellow indicates that the value may be changed. In the illustration above, the HDMI output can be toggled between 2 channel LPCM and 6 channel (5.1) channel LPCM audio using the Audio Channel selection button.



Audio channel selection button

Note that HDMI does not support 8 channels (7.1) of audio. Therefore, the 7.1 CH option cannot be selected.

## PATTERN SUMMARY

### External Optical Audio Input

Changing the audio input to EXT OPTICAL, using the Audio Input Selection button will produce the following screen:

```
Audio Pattern
INPUT: Ext. OPTICAL

____ OUTPUT ____
Analog 7.1CH: 2CH
OPTICAL/COAX: Bypass
HDMI: Bypass

____ Source Format Detection ____
App Type: None
Audio Coding: None
Sampling Rate(kHz): None

[EXT. 7.1CH/OPTICAL/SINEWAVE]. Audio Source
```

In the example above, since no optical input was used, the Source Format Detection displays None.



**NOTE:** The External Optical Audio Input does *not* support bitstream decoding.

### Internal Sinewave Generator

The third option (INT SINEWAVE) uses the internal sine wave generator:

```
Audio Pattern
INPUT: Int. Sinewave

____ OUTPUT ____
Analog 7.1CH: 2/6/8CH
OPTICAL/COAX: LPCM 2CH 48KHz
HDMI: LPCM 2/6/8CH 48/96/192KHz
I2S Bus: On/Mute

[FAV.].I2S Bus

[OPTION]. HDMI-OUT Sampling Rate
[2CH/5.1CJ/7.1CH].
    Analog/HDMI-OUT Audio Channels

[EXT. 7.1CH/OPTICAL/SINEWAVE]. Audio Source
```

## PATTERN SUMMARY

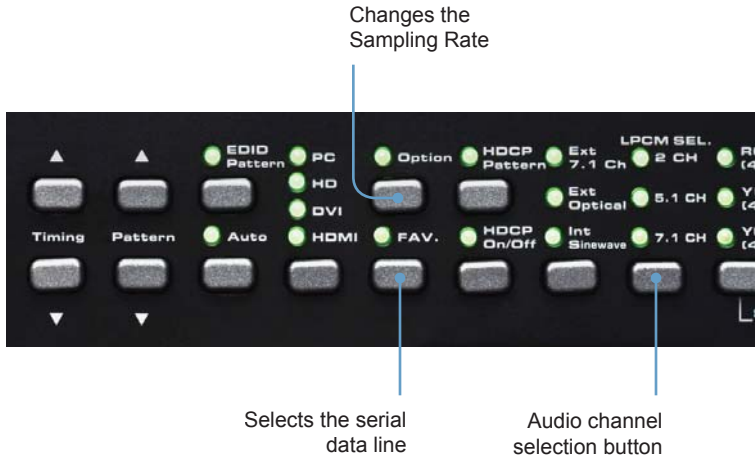

The I<sup>2</sup>S data line option is only present when the HD Pattern Signal Generator is set to 5.1 CH or 7.1 CH audio. In 2 CH mode, the I<sup>2</sup>S bus can only be enabled or disabled (muted). Use the [FAV] button to change the I<sup>2</sup>S bus options.

When the output is set to 5.1 (6 channel) audio, the I<sup>2</sup>S options are:

I<sup>2</sup>S Bus: On, Mute, SD0, SD1, and SD2

When the output is set to 7.1 (8 channel) audio, the I<sup>2</sup>S options are:

I<sup>2</sup>S Bus: On, Mute, SD0, SD1, SD2, and SD3

# PATTERN SUMMARY

## HDCP

### Pattern 40 (P40)

This pattern displays HDCP information such as handshaking and link integrity test. If the sink (output device) is a repeater, both the  $B_{KSV}$  and  $B_{KSV}$  are displayed.

P40

HDCP



When the HDCP pattern is selected, the display will appear as follows:

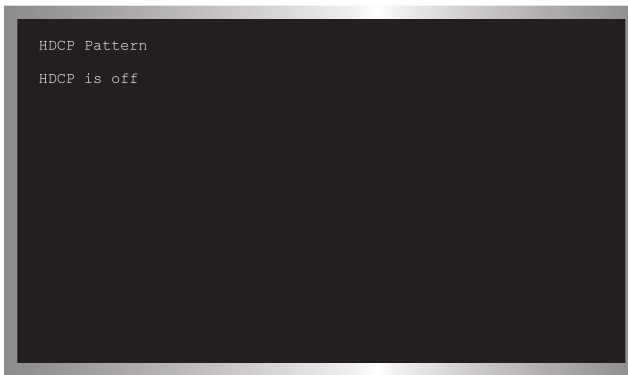

**TIP:** The HDCP pattern (P40) can also be directly accessed by pressing the [HDCP] button on the top panel.

By default, HDCP is disabled. Press the [HDCP] button on the front panel to enable HDCP. HDCP can be enabled or disabled for any pattern, except for the EDID pattern (P38).

Enables or disables  
HDCP



## PATTERN SUMMARY

Once HDCP has been enabled, the screen will appear similar to the following:

```
HDCP Pattern
1. Sink HDCP port detects: PASS
2. Source writes An to Sink: PASS
   An: F8 0C 74 A2 24 4F 08 19
3. Source writes Aksv to Sink: PASS
   Aksv: 3B D1 6C 90 AD
4. Read and Verify Sink Bksv: PASS
   Bksv: 1B C3 0D 59 E9
5. Compare R0Tx / R0Rx: PASS
6. Authentication Process: PASS

_____ Link Integrity _____
  RiTx: 306B
  RiRx: 306B Sink is not a repeater
  Count: 161
```

The HDCP pattern provides a full three phase authentication:

### Phase 1:

- a The HD Pattern Signal Generator writes a 64-bit random number ( $A_N$ ) to the sink / receiver (Rx).
- b The receiver responds by sending its own KSV ( $B_{KSV}$ ) to the transmitter (Tx). The Receiver also sends the repeater bit, used to determine if the sink / receiver acts as a repeater. During this step, the transmitter also verifies that  $B_{KSV}$  has not been revoked and has the proper format
- c If  $A_{KSV}$  and  $B_{KSV}$  are deemed to be valid, then the receiver (sink) and transmitter (source) each generate R0 (the receiver generates  $R_{0r}$ .  $R_{0r}$  is read by the transmitter and compared with  $R_0$ . If  $R_0 = R_{0r}$ , then the authentication phase is successful. If they are not equal, HDCP authentication will fail.

### Phase 2:

- d As long as  $R_0 = R_0'$ , the transmitter will begin sending encrypted video.

### Phase 3:

- e Every 128 frames (2 sec), the Tx and Rx generate a value  $R$  which is similar to the  $R_0$  values. Comparing these values between the Tx and Rx verifies that the link is synchronized.

# PATTERN SUMMARY

In the example above, the HDCP authentication process is successful. Note that the sink (Rx) was not identified as a *repeater*. For a display, this is normal.



**NOTE:** A repeater is defined as an active device which has one or more HDMI inputs and one or more HDMI outputs that work with HDCP. A repeater is an active device because it decrypts HDCP content on the input (Rx) and re-encrypts on the output (Tx).

## Motion

### Pattern 41 (P41)

This pattern produces a 10x10 pixel block that moves horizontally across the screen, from right to left. See page 48 for details on modifying this pattern.

P41

Motion



## Data Analysis

### Pattern 42 - Pattern 44 (P42 - P44)

These patterns are used to detect HDMI / DVI timings, input video packets, and infoframe analysis.

P42

In Timing



The In Timing pattern will display timing information about an incoming video signal. Connect the source signal to the HDMI or VGA input connector.

If no input signal is detected (or is not connected), the top line will display No Signal.

No input signal detected

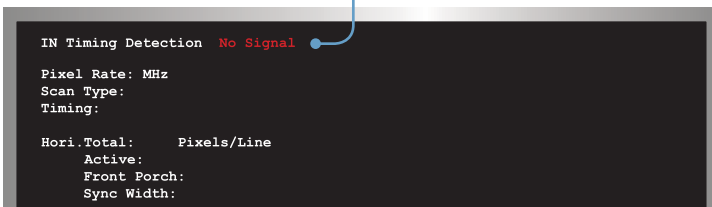



## PATTERN SUMMARY

When a valid video input signal is detected, the In Timing pattern will display information similar to the following:

```
IN Timing Detection No Signal
Pixel Rate:148 MHz PR:x1
Scan Type:Progressive
Timing:1920x1080P60

Hori.Total:2200 Pixels/Line
Active:1920
Front Porch:88
Sync Width:44
Sync Polarity:Positive
Freq.:67 KHz

Vert.Total:1125 Lines/Field
Active:1080
Front Porch:4
Vs Width+Back Porch:41
Sync Polarity:Positive
Freq.:60 Hz

[OPTION].Pull Hot-Plug
```

Press the [OPTION] button to perform a hot-plug (HPD) event. Triggering an HPD event is similar to disconnecting and reconnecting the input source.

P43

In Video



The In Video pattern provides information about color space, color depth, extended colorimetry (if applicable), HDCP, and AVI infoframe information.

```
IN Timing Detection No Signal

Signal Type:HDMI AVMUTE:OFF
HDCP Encryption:No
Timing:1920x1080P60
Color Depth:24 bits

___ AVI Infoframe ___
Color Space:RGB
Colorimetry:No Data
Aspect Ratio:No Data
Extended Colorimetry:No Data
RGB Color Range:Default
Video Id. Code:16 1920x1080p59/60 16:9
Pixel Repetition:x1

SPD Vendor Name:None
SPD Product Description:None
SPD Device Information:None

[OPTION].Pull Hot-Plug
```

## PATTERN SUMMARY

As with the In Timing pattern (P42), if a valid signal is not detected on the input, the top line will display No Signal.

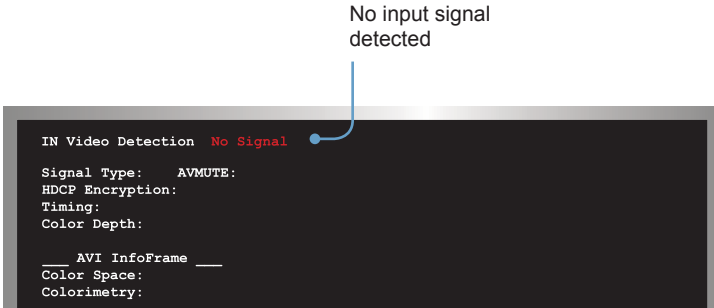

Press the [OPTION] button to trigger an HPD event.

P44

In Audio



The In Audio pattern provides audio information, including sampling rate, bit depth, audio encoding, and the number of audio channels.

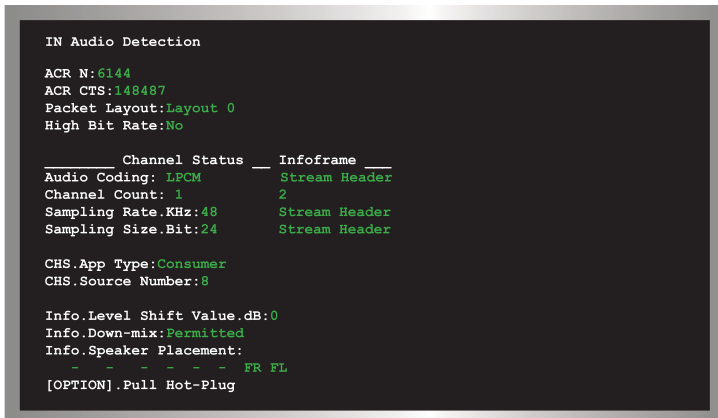

If an audio signal is not detected on the input, the In Audio Detection will indicate No Signal.

Use the [OPTION] button to trigger an HPD event.

# PATTERN SUMMARY

---

## System Setup

### Pattern 45 (P45)

Built-in Rx EDID setup, IR remote address setup.

P45

System Setup



When the System Setup pattern is selected, the display will appear as follows:

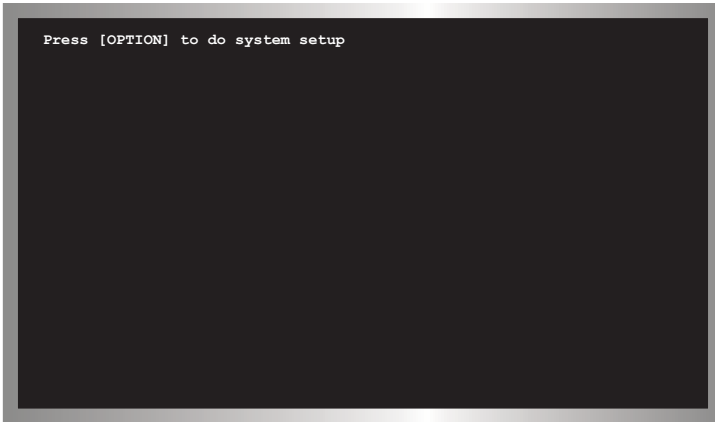

Press the [OPTION] button to bring up the following screen:

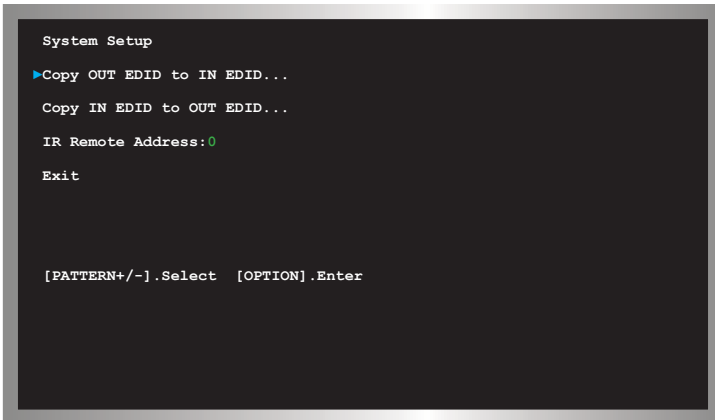

## PATTERN SUMMARY

---

There are four options under the System Setup pattern. Use the ▲ or ▼ buttons to select the desired option. Press the [OPTION] button to accept the selection.

### 1 Copy OUT EDID to IN EDID

Copies the EDID from the device/display connected to the HD Pattern Signal Generator and stores it in a local buffer on the unit. The EDID can be uploaded to another output device.



**WARNING:** The EDID data is stored in volatile memory. Any power disruption will erase the contents of the buffer.

### 2 Copy IN EDID to OUT EDID

Copies the EDID data stored in the local buffer (using the Copy OUT EDID to IN EDID option), to the device connected to the output of the HD Pattern Signal Generator.

### 3 IR Remote Address

Changes the IR channel of the HD Pattern Signal Generator, when used with the IR Remote Control Unit. An IR Remote Control Unit is not included with this product at this time.

### 4 Exit

Returns to the first screen of the System Setup pattern.

## TIMING SUMMARY

---

The following table lists the available graphic and video timings used by the HD Pattern Signal Generator.

Timing Number	Timing
T01	640 x 480 @ 60 Hz
T02	640 x 480 @ 72 Hz
T03	640 x 480 @ 75 Hz
T04	640 x 480 @ 85 Hz
T05	800 x 600 @ 56 Hz
T06	800 x 600 @ 60 Hz
T07	800 x 600 @ 72 Hz
T08	800 x 600 @ 75 Hz
T09	800 x 600 @ 85 Hz
T10	1024 x 768 @ 60 Hz
T11	1024 x 768 @ 70 Hz
T12	1024 x 768 @ 75 Hz
T13	1024 x 768 @ 85 Hz
T14	1280 x 960 @ 60 Hz
T15	1280 x 960 @ 85 Hz
T16	1280 x 1024 @ 60 Hz
T17	1280 x 1024 @ 75 Hz
T18	1280 x 1024 @ 85 Hz
T19	1600 x 1200 @ 60 Hz
T20	1920 x 1200 @ 60 Hz
T21	720 x 480i @ 59 Hz
T22	720 x 480i @ 60 Hz
T23	720 x 480p @ 59 Hz
T24	720 x 480p @ 60 Hz
T25	1280 x 720p @ 59 Hz
T26	1280 x 720p @ 60 Hz
T27	1920 x 1080i @ 59 Hz
T28	1920 x 1080i @ 60 Hz
T29	1920 x 1080p @ 59 Hz
T30	1920 x 1080p @ 60 Hz

## TIMING SUMMARY

---

Timing Number	Timing
T31	720 x 576i @ 50 Hz
T32	720 x 576p @ 50 Hz
T33	1280 x 720p @ 50 Hz
T34	1920 x 1080i @ 50 Hz
T35	1920 x 1080p @ 50 Hz
T36	1920 x 1080p @ 23 Hz
T37	1920 x 1080p @ 24 Hz
T38	1366 x 768 @ 60 Hz
T39	1366 x 768 @ 50 Hz



**NOTE:** Analog PC output (VGA) only supports VESA (VGA through WUXGA) timings. Analog HD output only supports SD / HD (480i, 480p, 576i, and 576p) timings. HDMI / DVI output supports all timings. Timings cannot be edited.

# HD PATTERN SIGNAL GENERATOR SOFTWARE

## HD-SIGGEN Software

The HD Pattern Signal Generator can be controlled via RS-232 on a PC running Windows®, using the HD-SIGGEN software. The program is available for download on the Gefen Web site: <http://www.gefen.com/kvm/support/download.jsp>

### Installing the Software

1. Unzip the archive file, containing setup.exe, SETUP.LST, and version.txt.
2. Run the setup.exe file by double-clicking on it.

setup.exe	2/22/2004 11:00 PM	Application
SETUP.LST	3/1/2011 1:39 PM	LST File
version.txt	3/1/2011 1:41 PM	Text Document

3. If the installer is running under Windows 7®, the following dialog may appear:

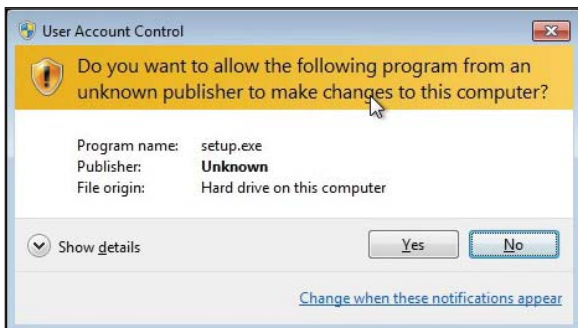

Click Yes to allow the installer to continue.

## HD PATTERN SIGNAL GENERATOR SOFTWARE

- The installer will begin by copying the required installation files, to the hard drive:



- After the required files have been copied to the hard drive, the installer Welcome screen will appear:



Click the OK button to continue with the installation.

Click the Exit Setup button to exit the installer.



**NOTE:** If the installer is cancelled, the installer will remove the files that were copied, earlier in the installation process.



## HD PATTERN SIGNAL GENERATOR SOFTWARE

- The destination directory can be changed. The default installation directory for Windows 7® is C:\Program Files(x86)\HD-SIGGEN. For other versions of the Windows® operating system, the default installation location will be C:\Program Files\HD-SIGGEN.

Click to install to the default directory

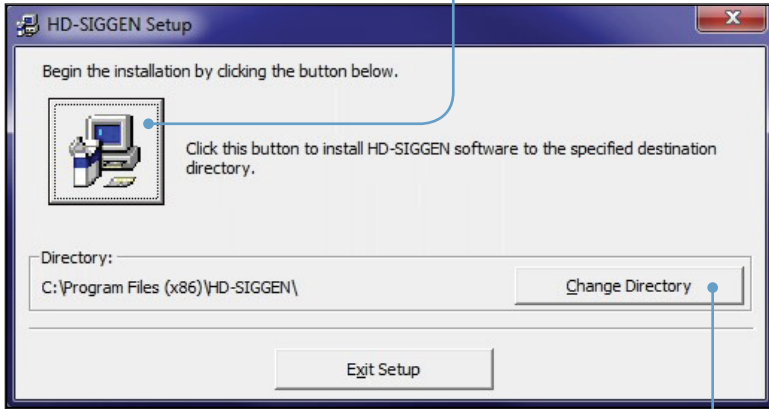

Click to change the default directory

- During the installation process, the following message will be displayed:

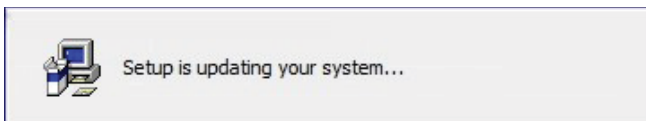

## HD PATTERN SIGNAL GENERATOR SOFTWARE

- After the installer has successfully completed the installation process, the following message box will be displayed:

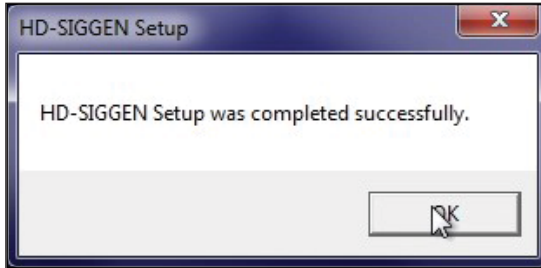

Click the OK button to dismiss the message box and exit the installer.

### Connecting the RS-232 cable

Before launching the HD Pattern Signal Generator software, an RS-232 cable must be connected from the back of the HD Pattern Signal Generator to the computer which has the HD Pattern Signal Generator software installed.

RS-232 port on the back of the HD Pattern Signal Generator



# HD PATTERN SIGNAL GENERATOR SOFTWARE

## Running the HD Pattern Signal Generator Software

1. Launch the HD Pattern Signal Generator Software by clicking on the application icon in the Windows® Start Menu:

The example below, shows the HD-SIGGEN application icon as it appears in the Windows 7® Start Menu:



# HD PATTERN SIGNAL GENERATOR SOFTWARE

After the HD Pattern Signal Generator is launched, the following screen will be displayed:



2. Select the COM port from the pull-down list. COM port 1 is selected by default.
3. Click the Connect button to initialize the connection between the software and the HD Pattern Signal Generator.

If you are unable to connect to the HD Pattern Signal Generator, make sure that the correct COM port is selected in the software. The Disconnect button will turn red if the connection between the software and the HD Pattern Signal Generator cannot be established.

The Connect button will turn green to indicate a successful connection

The Disconnect button will turn red to indicate no connection.

Selects the COM port

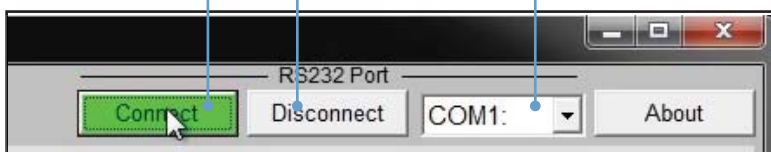

# HD PATTERN SIGNAL GENERATOR SOFTWARE

## Selecting the Timing

1. Use the Timing Select button to select the timing / resolution of the output signal.
2. Press the SET button to set the timing.

Select the timing  
in the Timings window

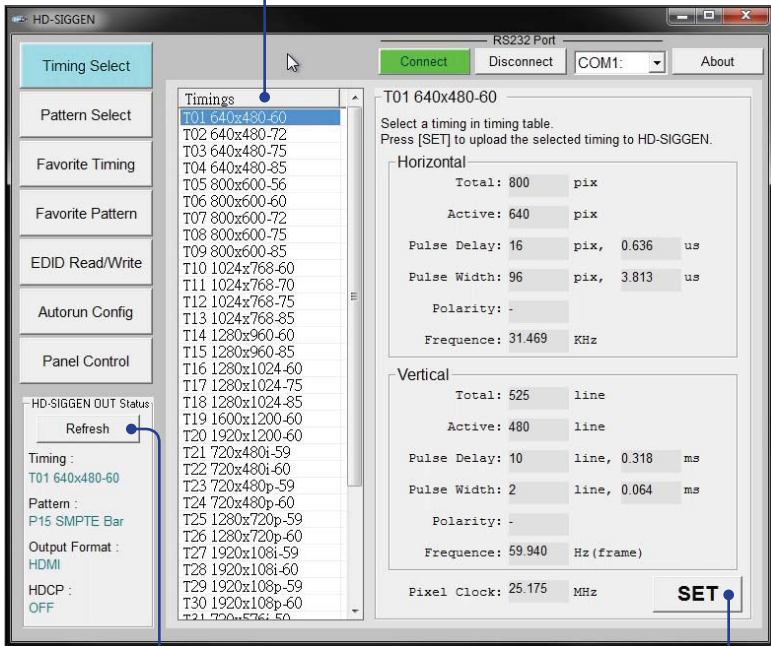

Retrieves the current  
settings

Click the SET button  
to enable the timing



**NOTE:** After changing a timing, pattern, the output format, or toggling HDCP, make sure to press the Refresh button on the left side of the window. The HD-SIGGEN Status window is not automatically updated, even if a change has been made through the software or using the front panel. Clicking the Refresh button will retrieve the current settings from the HD Pattern Signal Generator. Otherwise HD-SIGGEN Status window will display "Link Error".

# HD PATTERN SIGNAL GENERATOR SOFTWARE

## Selecting the Pattern

1. Use the Pattern Select button to select the desired pattern.
2. Press the SET button to enable the pattern.

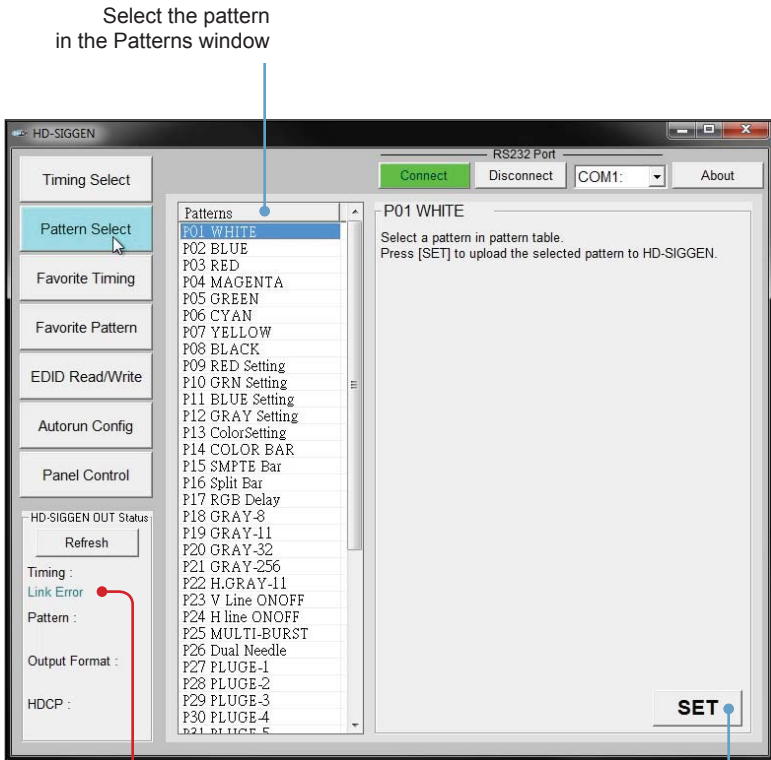

Click the SET button to enable the pattern



A "Link Error" message caused by the Refresh button not being pressed after connecting to the HD Pattern Signal Generator. Click Refresh to update the information.

# HD PATTERN SIGNAL GENERATOR SOFTWARE

## Unique Patterns

Pattern 13 (ColorSetting) and Pattern 41 (Motion) can be selected from the top panel buttons on the HD Pattern Signal Generator. However, they provide additional parameters which can only be modified using the HD-SIGGEN software.

## Color Setting

1. Select the ColorSetting pattern (P13).
2. Press the Download button to retrieve current color settings of the ColorSetting pattern.

Click the Download button to retrieve the current color settings

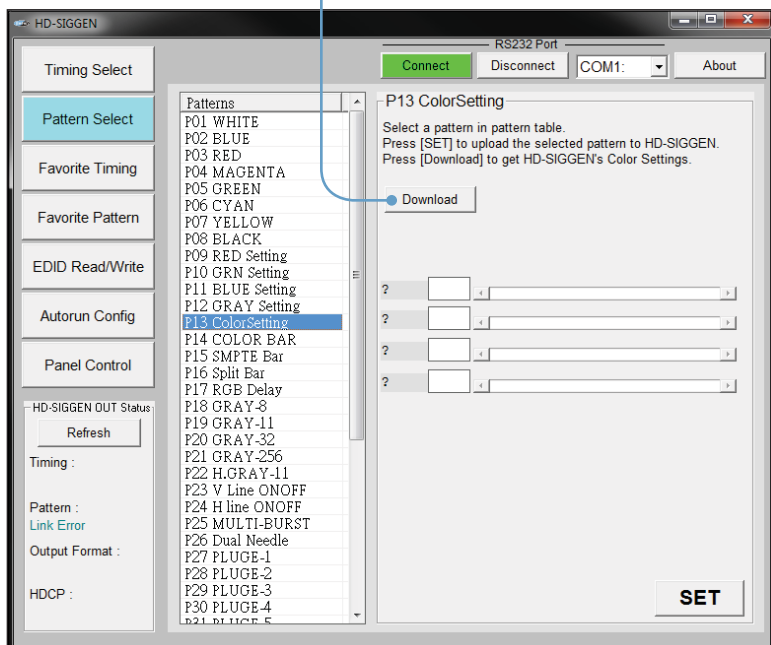

# HD PATTERN SIGNAL GENERATOR SOFTWARE

3. Adjust the Red, Green, Blue, and Grey sliders to render the desired color.
4. Press the SET button to upload the current settings to the ColorSetting pattern.

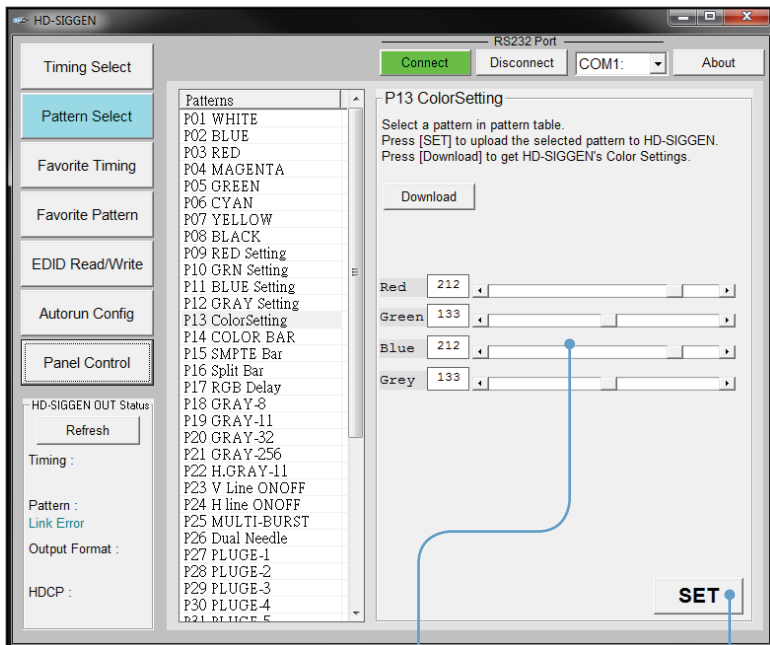

Use the sliders to adjust the color

Click the SET button to upload the new color settings



# HD PATTERN SIGNAL GENERATOR SOFTWARE

## Unique Patterns

Pattern 13 (ColorSetting) and Pattern 41 (Motion) can be selected from the top panel buttons on the HD Pattern Signal Generator. However, they provide additional parameters which can only be modified using the HD-SIGGEN software.

### Motion

1. Select the Motion pattern (P41).
2. Press the Download button to retrieve current color settings of the Motion pattern.

By default, the Motion pattern uses a block shape for the pattern.

Click the Download button to retrieve the current Motion pattern settings

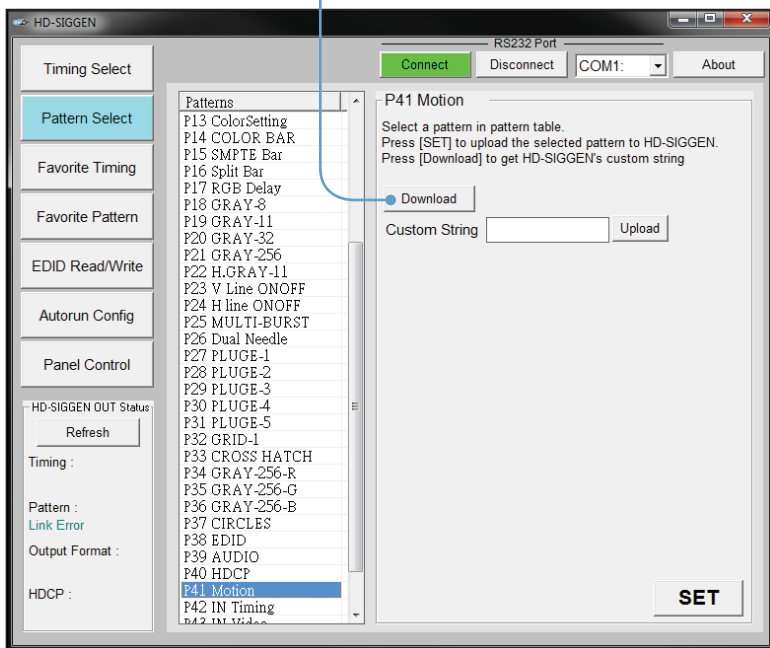

# HD PATTERN SIGNAL GENERATOR SOFTWARE

3. A custom string, up to 12 characters in length, can be entered in the Custom String field.
4. Click the Upload button to update the HD Pattern Signal Generator with the new pattern.

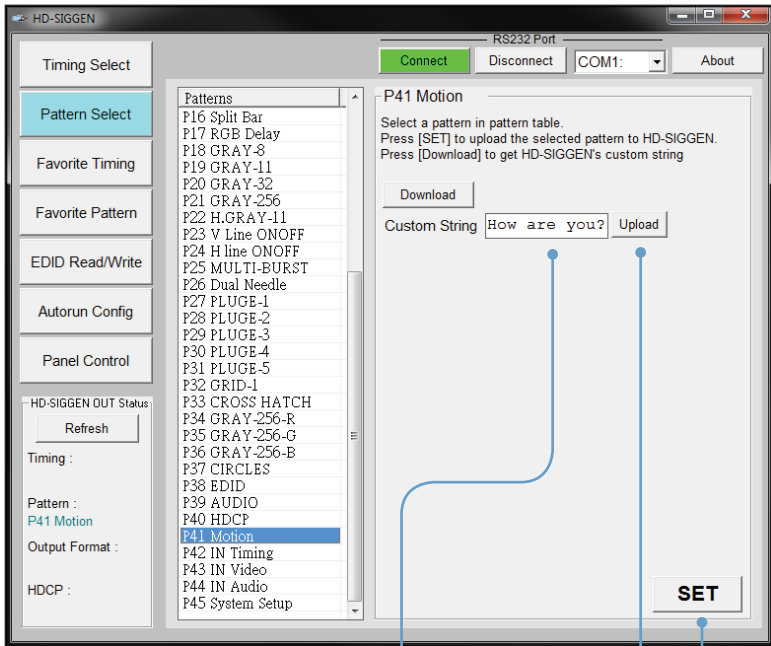

Use the sliders to adjust the color

A custom message can be added here

A custom message can be added here

5. Click the SET button to save the existing settings to the Motion pattern.

## Favorite Timing

A list of favorite timings can be assembled and stored in the HD Pattern Signal Generator. The [FAV] button, on the front panel, can then be used to cycle through the list of timings that is created.

1. In the Timings window, place a check mark in the boxes of the timings to be added to the Favorites list.

Use the Check All button to select all the timings in the Timings window. Use the Check None button to deselect any or all currently selected timings.

2. Press the SET button to upload the selected Timings to the HD Pattern Signal Generator. The list of Favorite will be available using the [FAV] button on the front panel of the HD Pattern Signal Generator.

Use the Download button to download and edit the Favorite timings on the HD Pattern Signal Generator.

Place a check mark by the timings to be added to Favorites

Press this button to download (and edit) the current Favorite list

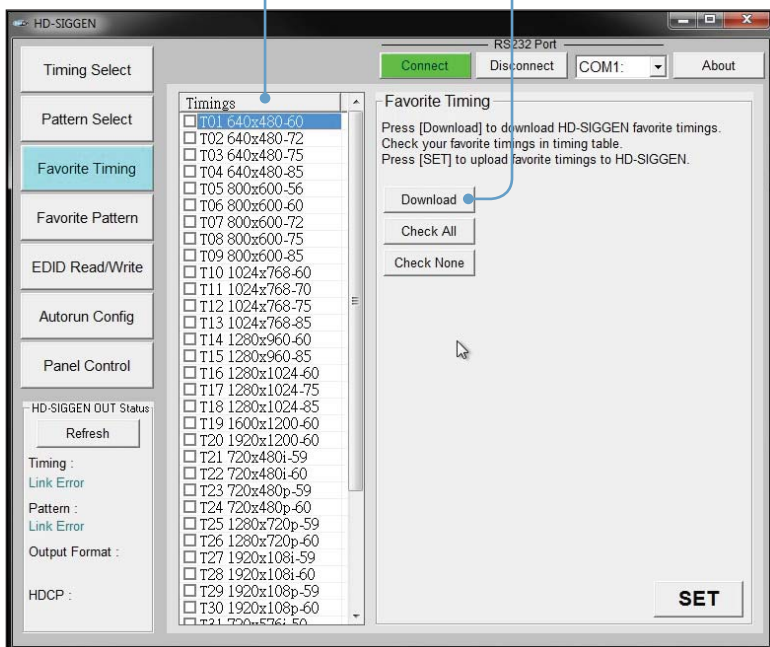

# HD PATTERN SIGNAL GENERATOR SOFTWARE

## Favorite Pattern

A list of favorite patterns can be assembled and stored in the HD Pattern Signal Generator. The [FAV] button, on the front panel, can then be used to cycle through the pattern list that is created.

In the Patterns window, place a check mark in the boxes, next to the timings to be added to the Favorites list.

Use the Check All button to select all the timings in the Patterns window. Use the Check None button to deselect any or all selected patterns.

1. Press the SET button to upload the selected Patterns to the HD Pattern Signal Generator. The list of Favorite will be available using the [FAV] button on the front panel of the HD Pattern Signal Generator.

Use the Download button to download and edit the Favorite patterns on the HD Pattern Signal Generator.

Place a check mark by the patterns to be added to the Favorites

Press this button to download (and edit) the current Favorite list

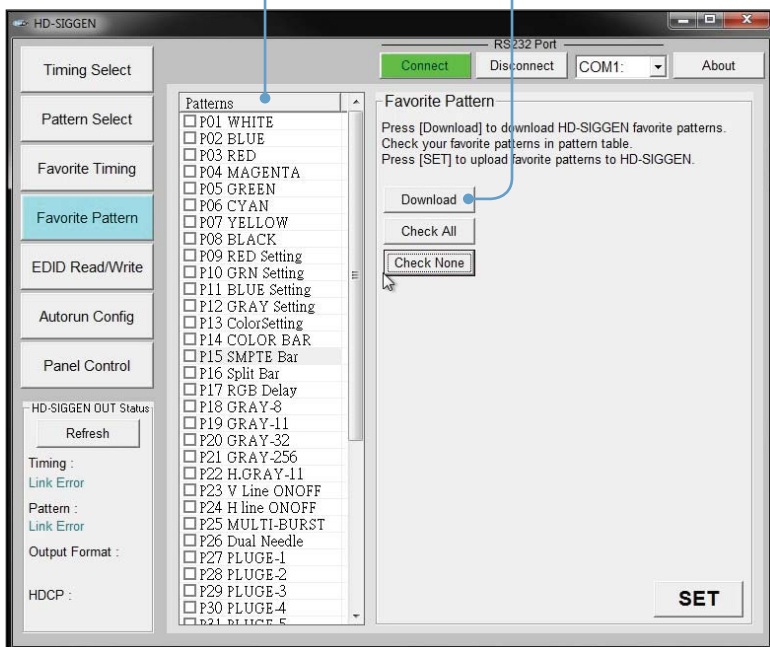

## EDID Read / Write

The HD Pattern Signal Generator has the ability to read EDID data. EDID data can also be saved, loaded, written, erased, compared, interpreted, and summed. Each of these features will be covered in this section. Clicking the EDID Read / Write button will display the following screen:

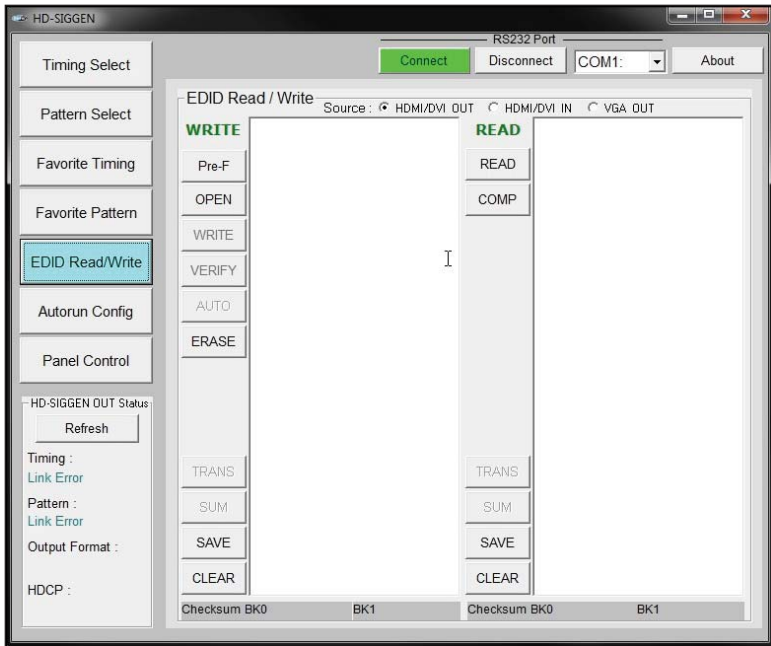

## Reading EDID

1. Select the Source by clicking one of the three radio buttons at the top portion of the screen.

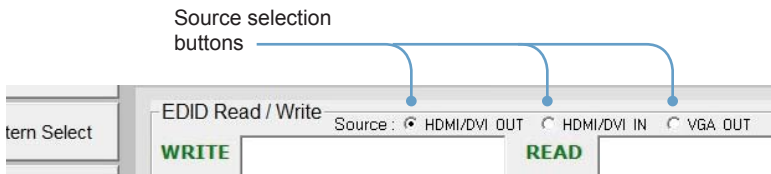

EDID can be read from a downstream sink (display, etc) or from the EDID stored in the HD Pattern Signal Generator. Click HDMI/DVI Out or VGA Out to read the downstream EDID. Click the HDMI / DVI In radio button to read the EDID stored in the HD Pattern Signal Generator.

# HD PATTERN SIGNAL GENERATOR SOFTWARE

In this example, the EDID is being read from the display connected to the HD Pattern Signal Generator.

1. Click the READ button on the READ Panel.

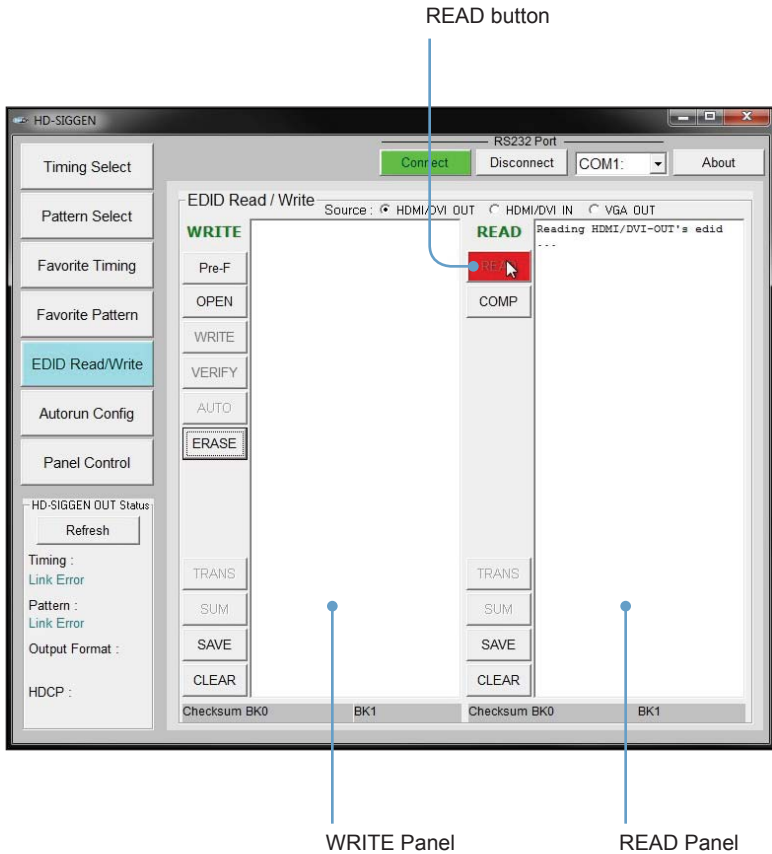

The READ and COMP (compare) functions are only available under the READ panel. The Pre-F, OPEN, WRITE, VERIFY, AUTO, and ERASE function are only available under the WRITE panel.

The TRANS, SUM, SAVE, and CLEAR functions are available under both the WRITE and READ panels.



**NOTE:** Disabled buttons, under the WRITE or READ panel, will become active when EDID data is loaded into the associated panel.

# HD PATTERN SIGNAL GENERATOR SOFTWARE

- If the EDID is read successfully, the EDID will appear in the READ Panel:

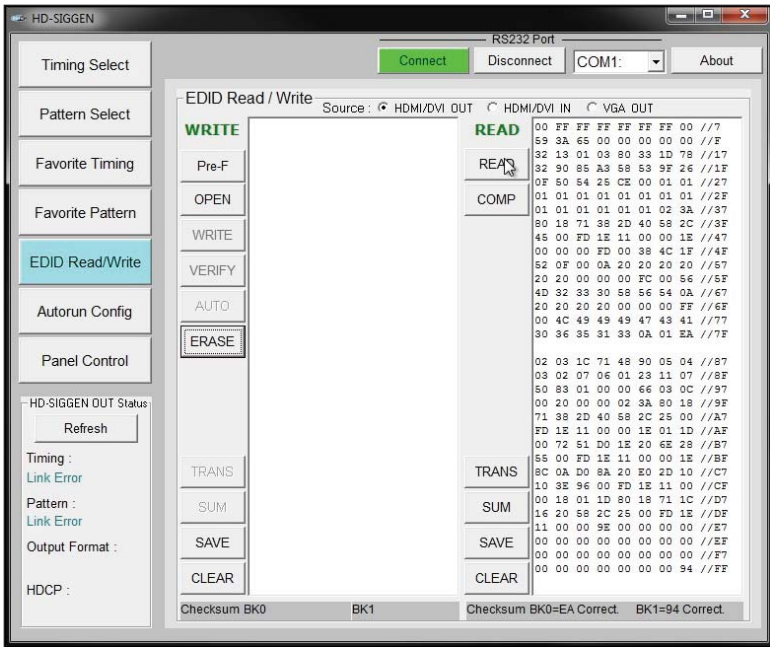

## Translating the EDID

After the EDID has been read, it can be translated into verbose form by clicking the TRANS (Translate) button in the READ panel:

Click the TRANS button to display the EDID in verbose form

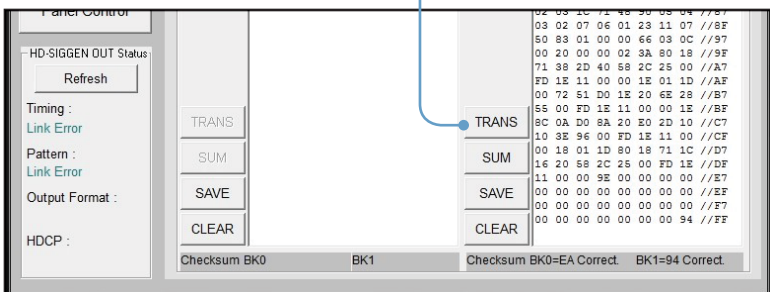

# HD PATTERN SIGNAL GENERATOR SOFTWARE

The Translate [Read] EDID screen:

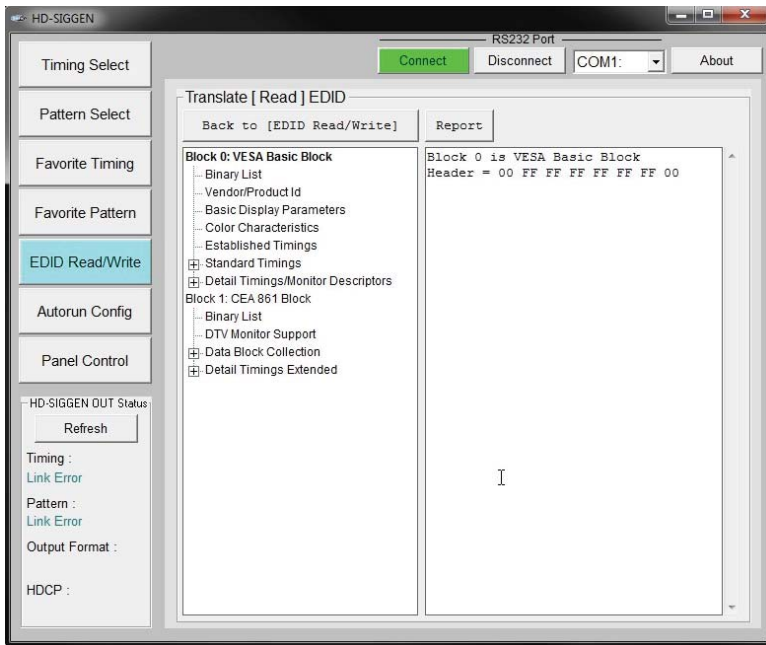

Clicking on the one of the items in the panel on the left, will display the information in the panel on the right. Some items will have a [+] symbol next to them, indicating that additional information is available for that section:

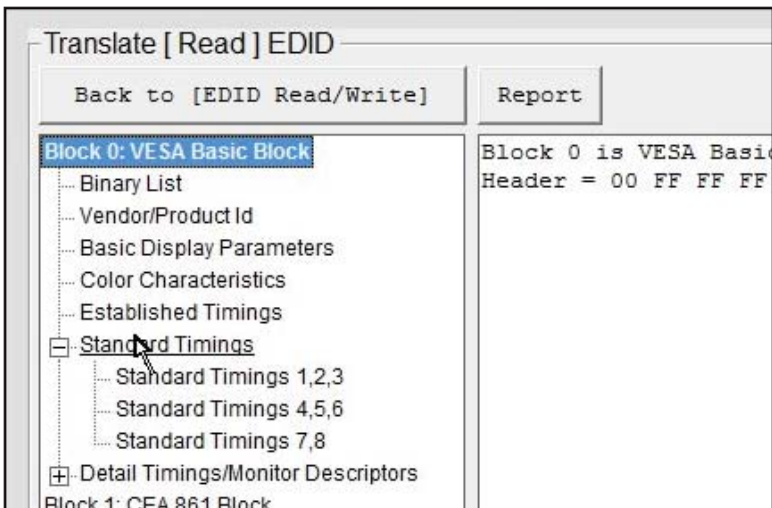



## HD PATTERN SIGNAL GENERATOR SOFTWARE

Click the [+] button to expand any section where additional information is present. In the example below, the [+] button has changed to a [-] symbol after the Standard Timings section has been expanded:

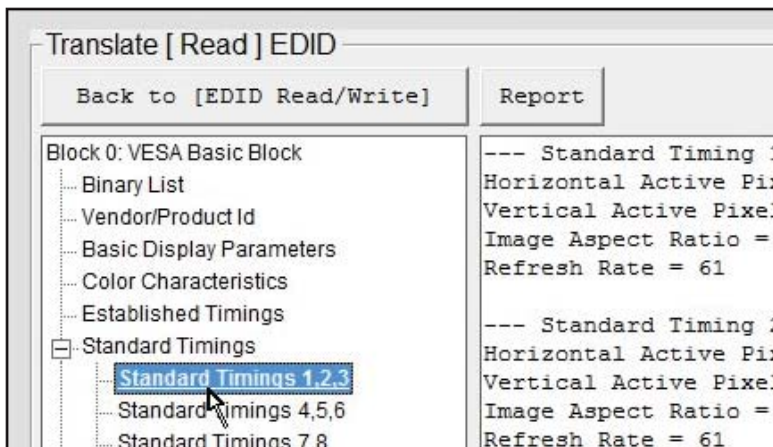

The information about the Standard Timing 1, Standard Timing 2, and Standard Timing 3 is listed in the panel on the right.

### Generating an EDID Report

Clicking the Report button can be used to save the verbose form of the EDID to a file:

Click the Report button  
to view a complete listing  
of the EDID

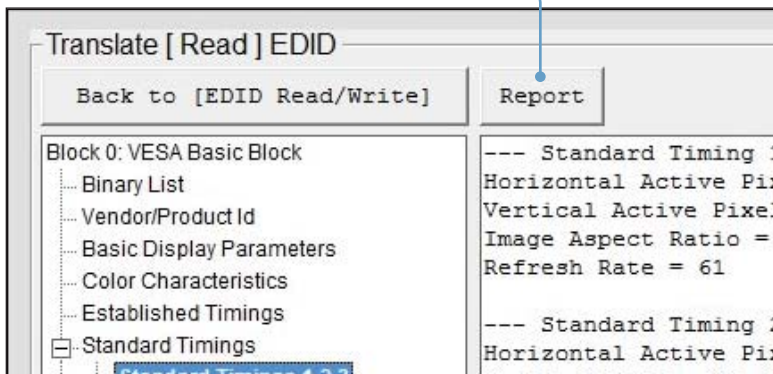

## HD PATTERN SIGNAL GENERATOR SOFTWARE

The EDID Report window is shown below. Click the Save button to save the file in .TXT format. Click the Exit button to return to the Translate EDID screen.

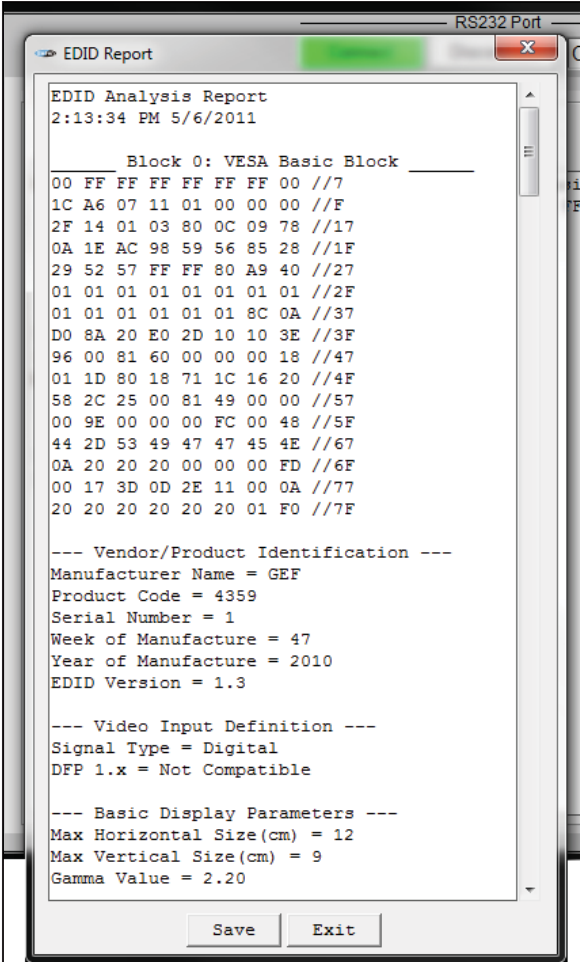

```
RS232 Port
EDID Report
EDID Analysis Report
2:13:34 PM 5/6/2011

Block 0: VESA Basic Block
00 FF FF FF FF FF FF 00 //7
1C A6 07 11 01 00 00 00 //F
2F 14 01 03 80 0C 09 78 //17
0A 1E AC 98 59 56 85 28 //1F
29 52 57 FF FF 80 A9 40 //27
01 01 01 01 01 01 01 01 //2F
01 01 01 01 01 01 8C 0A //37
D0 8A 20 E0 2D 10 10 3E //3F
96 00 81 60 00 00 00 18 //47
01 1D 80 18 71 1C 16 20 //4F
58 2C 25 00 81 49 00 00 //57
00 9E 00 00 00 FC 00 48 //5F
44 2D 53 49 47 47 45 4E //67
0A 20 20 20 00 00 00 FD //6F
00 17 3D 0D 2E 11 00 0A //77
20 20 20 20 20 20 01 F0 //7F

--- Vendor/Product Identification ---
Manufacturer Name = GEF
Product Code = 4359
Serial Number = 1
Week of Manufacture = 47
Year of Manufacture = 2010
EDID Version = 1.3

--- Video Input Definition ---
Signal Type = Digital
DFP 1.x = Not Compatible

--- Basic Display Parameters ---
Max Horizontal Size(cm) = 12
Max Vertical Size(cm) = 9
Gamma Value = 2.20

Save Exit
```

# HD PATTERN SIGNAL GENERATOR SOFTWARE

## Generating the EDID Checksum

Once an EDID has been read or loaded into the HD Pattern Signal Generator, a checksum can be generated.

1. Read or load an EDID file into the HD Pattern Signal Generator.
2. Click the SUM button under the READ panel.

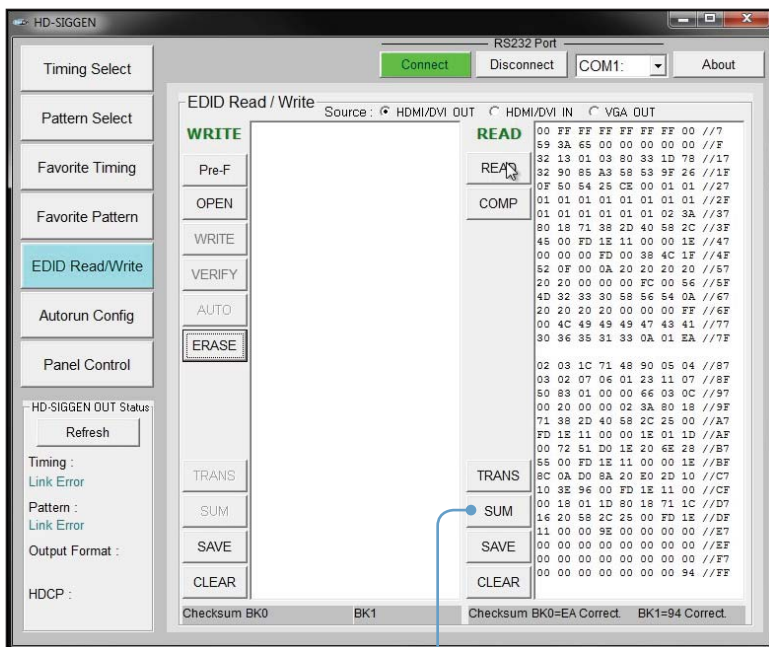

Click the SUM button to generate the EDID checksum

# HD PATTERN SIGNAL GENERATOR SOFTWARE

- The EDID Checksum dialog will be displayed. Select the method of how unused bytes will be calculated into the checksum by clicking either the 0x00 or 0xFF radio button.

Select how unused bytes will be used in calculating the checksum

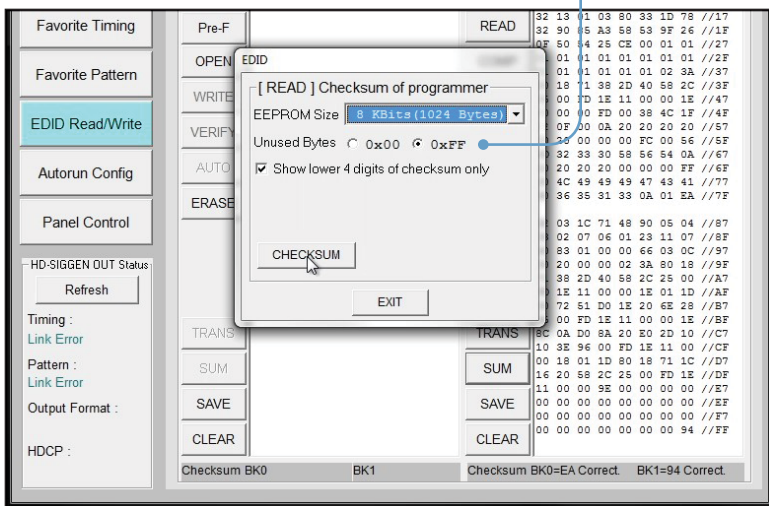

- Adjust the EEPROM size, if necessary, by selecting it from the EEPROM Size drop-down list: 256, 512, 1024, or 2048 bytes.

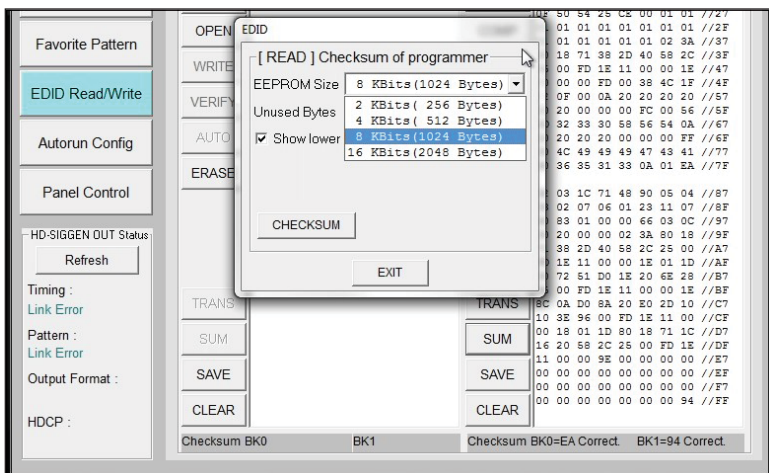

# HD PATTERN SIGNAL GENERATOR SOFTWARE

5. Click the CHECKSUM button to generate the EDID checksum.

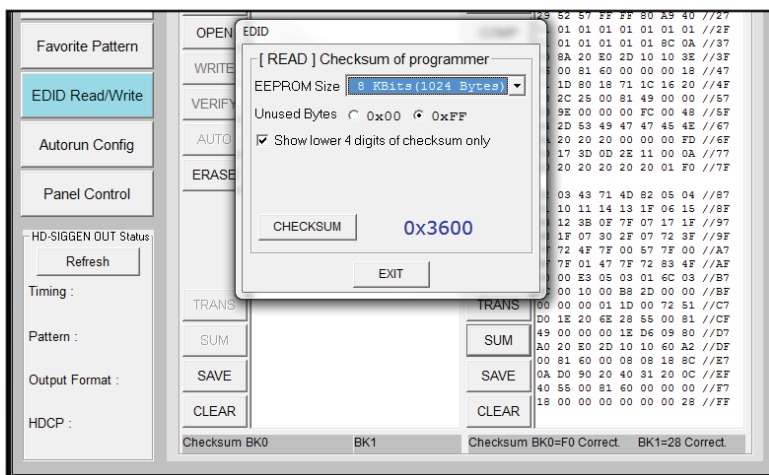

By default, the checksum will be restricted to the lower 4 digits. This feature can be disabled unchecking the *Show lower 4 digits of checksum only* box.

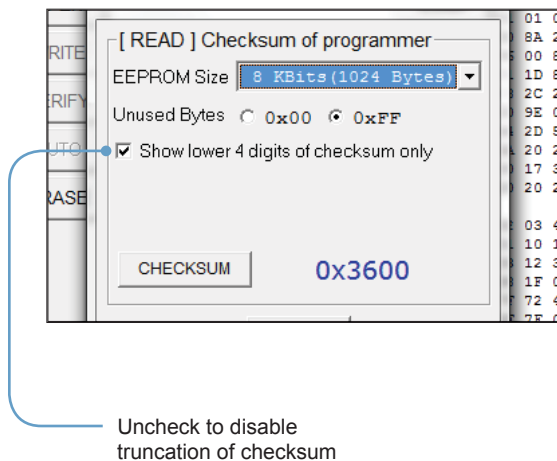

In the example above, if the checksum were calculated by disabling the *Show lower 4 digits of checksum only* feature, the result would be 0x33600.

# HD PATTERN SIGNAL GENERATOR SOFTWARE

## Saving an EDID to a File

Any EDID can be saved to a file, once it has been read into the HD Pattern Signal Generator.

1. Once an EDID has been read, click the SAVE button.

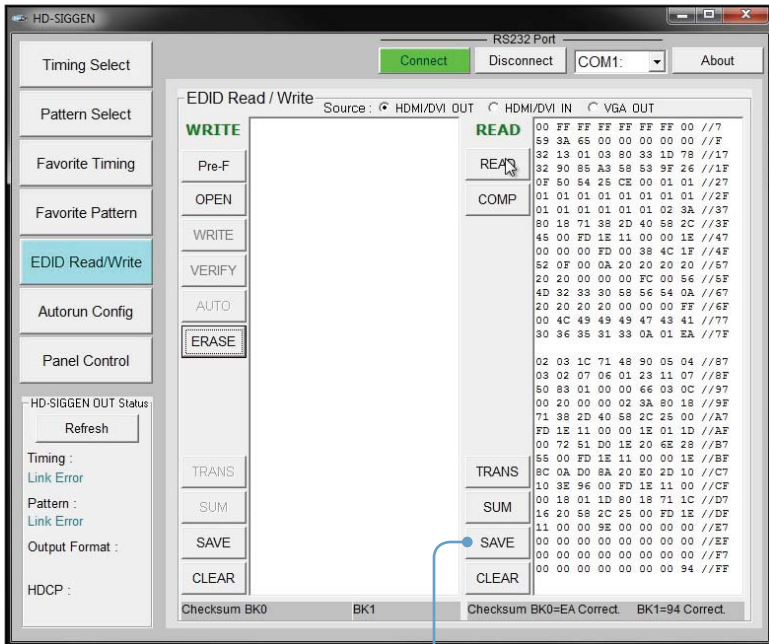

Click the SAVE button to save the EDID to a file.



# HD PATTERN SIGNAL GENERATOR SOFTWARE

4. Select the directory where the EDID file will be saved and click the Save button on the dialog box.

By default, the EDID file will be saved in the working directory of the HD Pattern Signal Generator software directory.

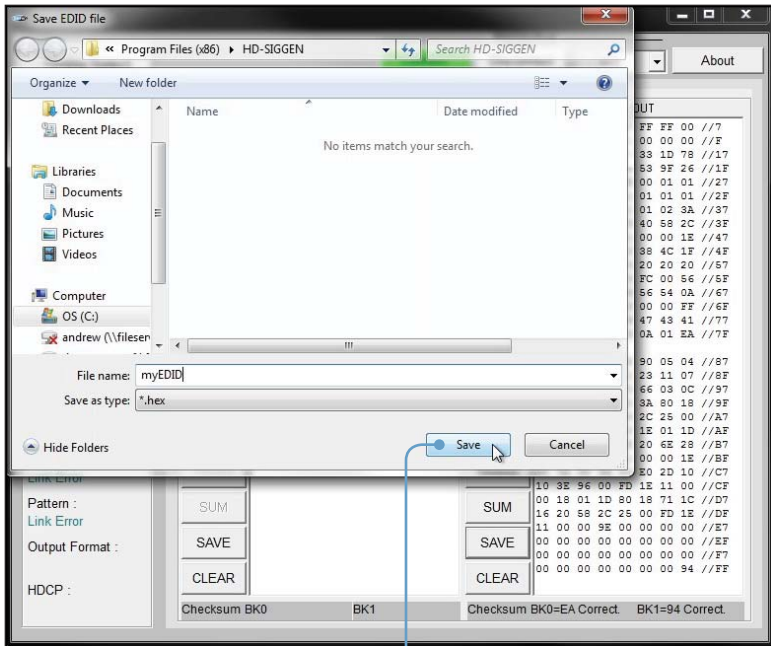

Click to save the EDID



# HD PATTERN SIGNAL GENERATOR SOFTWARE

## Clearing the EDID from Memory

1. Click the Clear button to clear the EDID from memory.

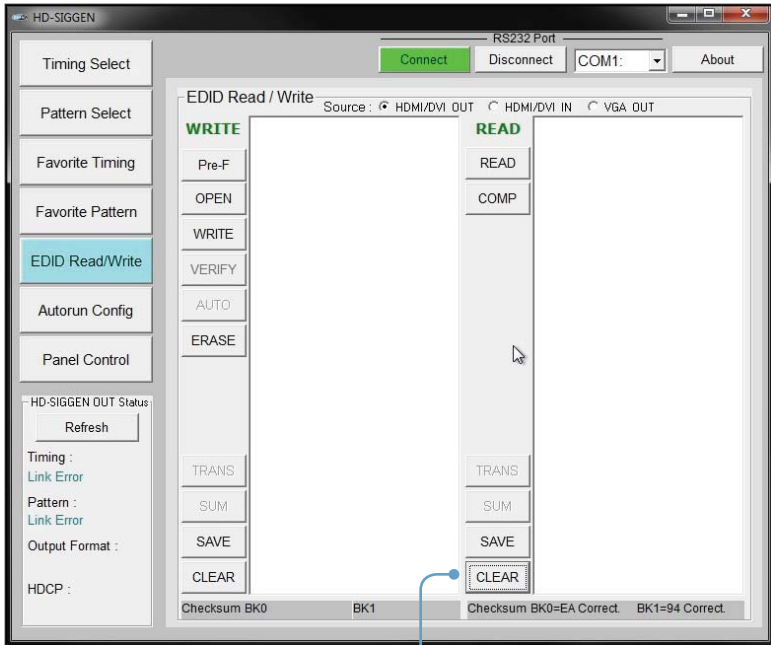

Clears the EDID from memory

If an EDID is loaded (OPEN) under the WRITE panel, use the CLEAR button to clear it from memory.

# HD PATTERN SIGNAL GENERATOR SOFTWARE

## Loading an EDID from a File

An EDID file in binary (.bin) format or in text format (.hex) can be loaded into the HD Pattern Signal Generator.

1. Click the OPEN button under the WRITE panel. If necessary, refer to page 61 on how to save an EDID to a file.

Click to open an EDID file

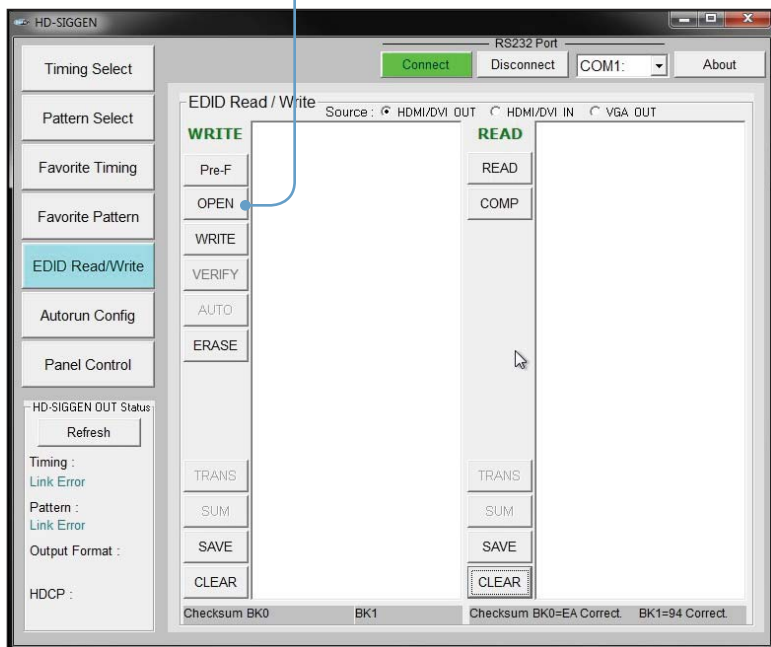

2. Select the EDID file to be opened.

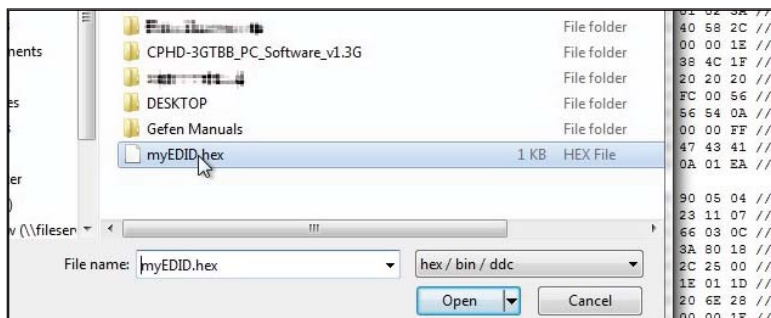

# HD PATTERN SIGNAL GENERATOR SOFTWARE

- The EDID file will be loaded into the HD Pattern Signal Generator and displayed in the WRITE panel.

In the example below, an EDID has been read using the HD Pattern Signal Generator software (using the READ function) and an EDID has been loaded from a file using the OPEN function.

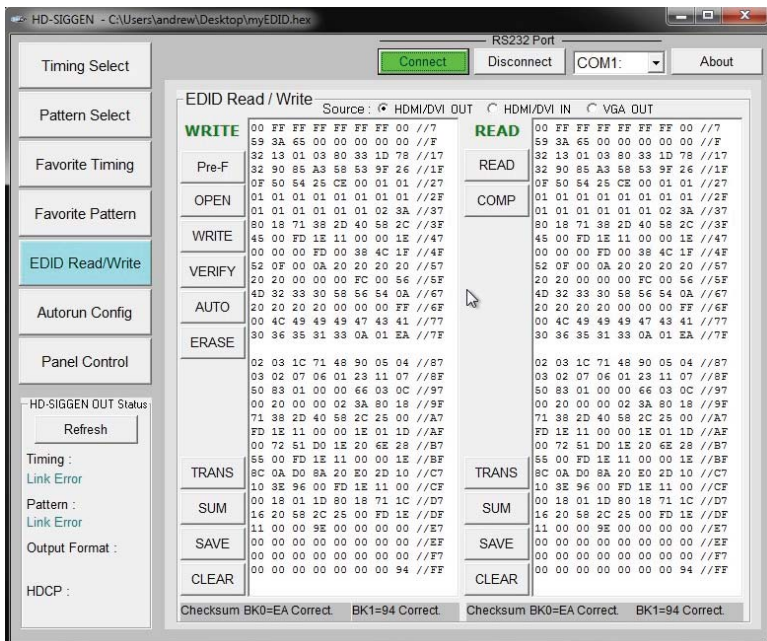

# HD PATTERN SIGNAL GENERATOR SOFTWARE

## Comparing EDID Data

The HD Pattern Signal Generator software can compare two EDID data structures. One EDID is read from a sink (display, A/V receiver, etc) and the other is loaded into the HD Pattern Signal Generator software using the OPEN function.

1. Read the source EDID by following the instructions starting on page 52.
2. Load an EDID into the HD Pattern Signal Generator by following the instructions starting on page 65.
3. Click the COMP button under the READ panel.

Click the COMP button  
to compare the two  
EDID data structures

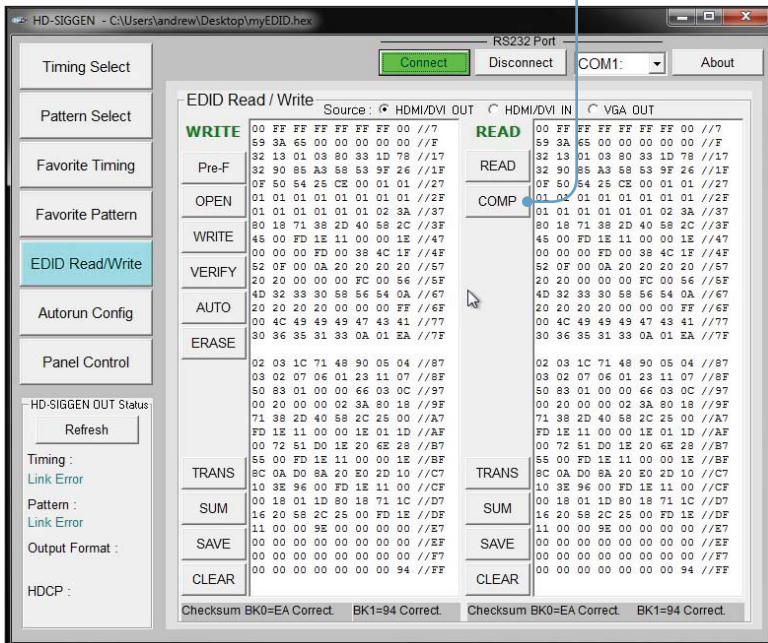

## HD PATTERN SIGNAL GENERATOR SOFTWARE

If the two EDID data structures are identical, then a message will be displayed indicating that the compare process has passed:

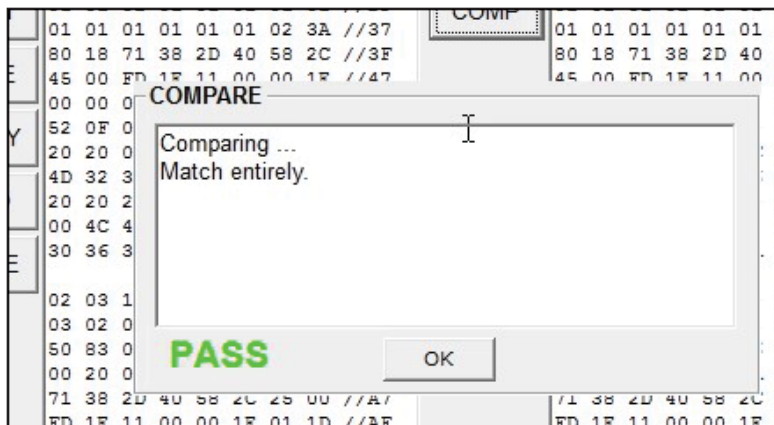

Click the OK button to return to the EDID Read / Write screen.

If there are differences in the two EDID data structures, then the compare process will fail. The number of reported comparison errors will also be displayed.

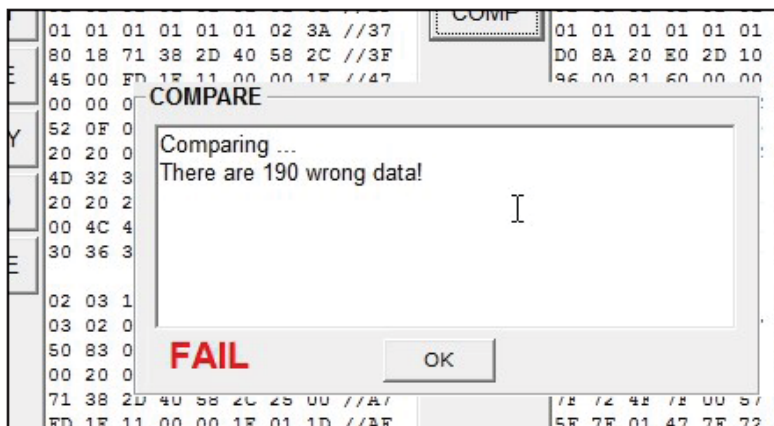

Click the OK button to return to the EDID Read / Write screen.

# HD PATTERN SIGNAL GENERATOR SOFTWARE

## Writing EDID to a Sink

After an EDID has been read from another source or loaded from a file, the EDID can be written to the sink connected to the output of the HD Pattern Signal Generator.



**WARNING:** Overwriting the EDID of a sink device may cause unwanted results. Be sure to save a copy of the EDID. This will allow the sink's EDID to be restored if necessary. Also note that not all device EDID data structures can be overwritten. If the sink cannot be programmed with a new EDID, the WRITE process will fail.

1. Load an EDID into the HD Pattern Signal Generator by following the instructions starting on page 65.
2. Click the WRITE button to write the EDID to the sink device.

Click to write the EDID data to the sink device

The screenshot shows the HD-SIGGEN software interface. The main window is titled "EDID Read / Write". At the top, there are buttons for "Connect" (green), "Disconnect", and "COM1:". Below this, there are tabs for "Source": "HDMI/DVI OUT", "HDMI/DVI IN", and "VGA OUT". The "WRITE" button is highlighted with a red circle and a blue arrow. A dialog box titled "Writing WRITE data ..." is open in the center, with an "OK" button. The interface includes various controls like "Timing Select", "Pattern Select", "Favorite Timing", "Favorite Pattern", "EDID Read/Write", "Autorun Config", "Panel Control", "HD-SIGGEN OUT Status", "Refresh", "Timing:", "Link Error", "Pattern:", "Link Error", "Output Format:", "HDCP:", "Pre-F", "OPEN", "WRITE", "VERIFY", "AUTO", "ERASE", "TRANS", "SUM", "SAVE", "CLEAR", "READ", "COMP", "TRANS", "SUM", "SAVE", "CLEAR". At the bottom, there are checksums: "Checksum BK0=EA Correct. BK1=94 Correct. Checksum BK0=EA Correct. BK1=94 Correct."

# HD PATTERN SIGNAL GENERATOR SOFTWARE

## Erasing the EDID from a Sink

The ERASE function will erase the EDID of a sink device.



**WARNING:** Be sure to save a copy of the sink's EDID before performing the ERASE function. This will allow the sink's EDID to be restored if necessary. Also note that not all device EDID data structures can be erased. If the sink's EDID cannot be erased, then the ERASE procedure will fail.

1. Make sure that the sink device is connected to the HD Pattern Signal Generator.
2. Click the ERASE button.
3. The HD Pattern Signal Generator software will prompt you before erasing the sink's EDID. Click the Yes button to continue with the erasure. Click No to return to the EDID Read / Write screen.

Click to erase  
the sink's EDID

The screenshot shows the HD-SIGGEN software interface. The main window is titled "HD-SIGGEN - C:\Users\andrew\Desktop\my DID.hex". The interface includes a sidebar on the left with buttons for "Timing Select", "Pattern Select", "Favorite Timing", "Favorite Pattern", "EDID Read/Write" (highlighted), "Autorun Config", and "Panel Control". The main area is titled "EDID Read / Write" and has a "Source" dropdown set to "HDMI/DVI OUT". It features two columns of hex data for "WRITE" and "READ", each with a "Pre-F", "OPEN", "WRITE", "VERIFY", "AUTO", "ERASE", "TRANS", "SUM", "SAVE", and "CLEAR" button. A "Refresh" button is located under "HD-SIGGEN OUT Status". A confirmation dialog box is overlaid on the interface, asking "Are you sure to erase sink's EDID ?" with "Yes" and "No" buttons. A blue arrow points from the text above to the "ERASE" button. At the bottom, there are four status indicators: "Checksum BK0=EA Correct", "BK1=94 Correct", "Checksum BK0=EA Correct", and "BK1=94 Correct".



# HD PATTERN SIGNAL GENERATOR SOFTWARE

## Opening Recent EDID Files

The HD Pattern Signal Generator software keeps a record of the last ten files which were opened or saved. To access the most recently used files, do the following:

1. Click the Pre-F button in the WRITE panel.
2. A list of the most recently used EDID files will appear in a drop-down window.
3. Highlight and click the EDID file to be loaded.

The Pre-F button quickly accesses the most recently used EDID files

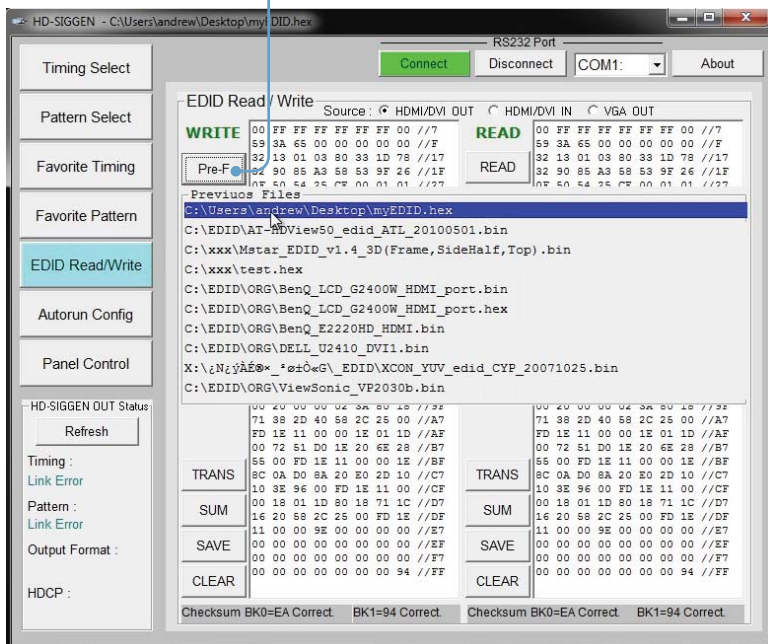



## Autorun Configuration

The Autorun Configuration option allows custom programming of timings and patterns used by the Autorun Demonstration mode (pressing the AUTO button on the front panel):

1. Click the Autorun Config button.
2. If necessary, you can press the Download button to read the current Autorun settings from the HD Pattern Signal Generator.
3. Select the Timing and/or Pattern from the timing drop-down list boxes.
4. Select the Duration (in seconds), from the interval drop-down box.
5. Click the Add / Replace button to add the current timing and pattern to the Autorun Configuration list.

Downloads current Autorun list

Adds or replaces the current timing / pattern

Deletes a timing / pattern from list

Timing selection

Pattern selection

Duration selection

Autorun Configuration list

Uploads current Autorun list

No.	Timing	Pattern	Interval (sec)
1			0
2			0
3			0
4			0
5			0
6			0
7			0
8			0
9			0
10			0
11			0
12			0
13			0
14			0
15			0
16			0
17			0
18			0

# HD PATTERN SIGNAL GENERATOR SOFTWARE

An existing timing and pattern set can be replaced by clicking (highlighting) the set, selecting the new timing and new pattern from the drop-down list boxes, then pressing the Add / Replace button.

Use the Delete button to remove a timing / pattern set from the Autorun Configuration Ilist.

6. Click the SET button to write the changes to the HD Pattern Signal Generator.

## Panel Control

The Panel Control screen allows remote control of the front panel buttons on the HD Pattern Signal Generator. The current settings will be indicated by green buttons.

The Download button is used to retrieve the current settings from the HD Pattern Signal Generator.

Downloads current  
Autorun list

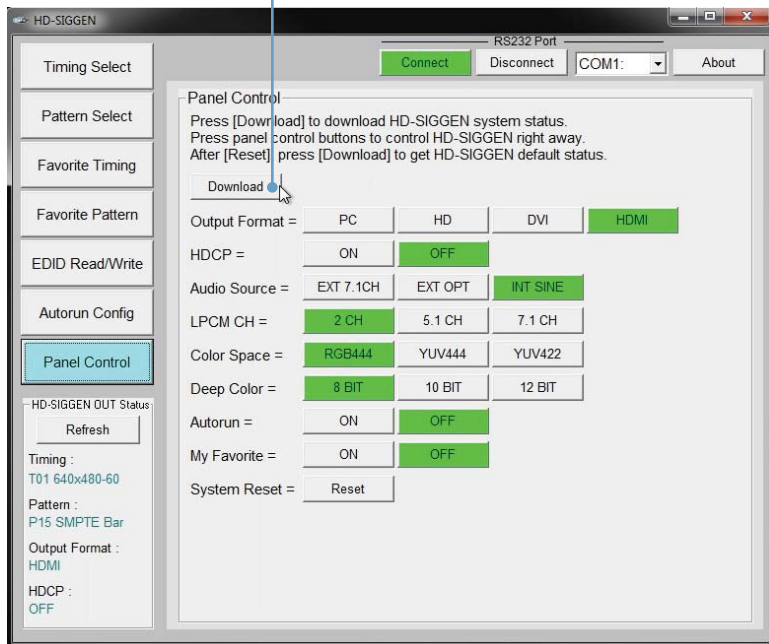

# HD PATTERN SIGNAL GENERATOR SOFTWARE

## Getting the Hardware and Firmware Version

Press About button on the top portion of the HD Pattern Signal Generator software.

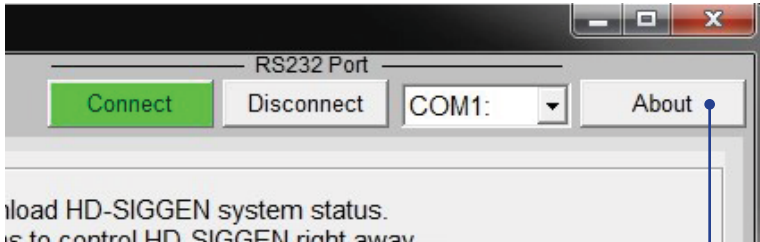

Press to display hardware and software information

The About screen will be displayed, showing the software and firmware versions:

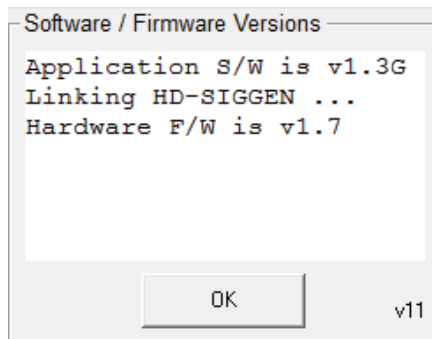

2. Press the OK button to dismiss the About box and return to the HD Pattern Signal Generator software window.

# RS-232 CONTROL

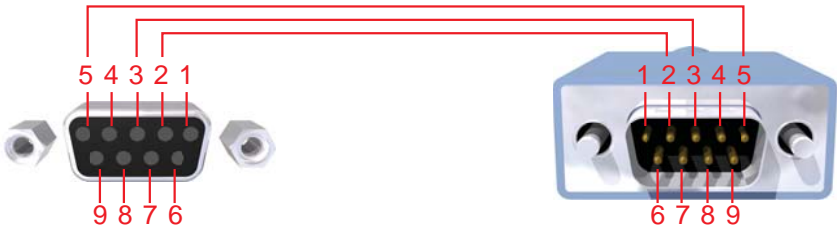

Only Pins 2 (RX), 3 (TX), and 5 (Ground) are used on the RS-232 serial interface

## RS232 Settings

Bits per second .....	19200
Data bits .....	8
Parity .....	None
Stop bits .....	1
Flow Control .....	None



NOTE: The return value will be displayed when using a terminal-based application, indicating the current value after executing the command.

## RS-232 COMMANDS

### Commands

Command	Description
<i>ASC001</i>	Audio source is from external L/R
<i>ASC002</i>	Audio source is from external OPTICAL
<i>ASC003</i>	Audio source is from internal Sinewave
<i>ASC999</i>	Query audio source status
<i>ATO000</i>	Set Autorun Off
<i>ATO001</i>	Set Autorun On
<i>ATO999</i>	Query Autorun Action status
<i>ATNnnn</i>	Autorun Number, nnn = 001 ~ 032 (see note 2 on page 81)
<i>ATTnnn</i>	Autorun Timing, nnn = 001 ~ 039
<i>ATPnnn</i>	Autorun Pattern, nnn = 001 ~ 050
<i>ATInnn</i>	Autorun time Interval, nnn = 005 ~ 600 (seconds)
<i>ATS999</i>	Query Autorun Configuration status
<i>CRRnnn</i>	Set the Red (Cr) ColorSetting value, nnn = 000 ~ 255
<i>CRGnnn</i>	Set the Green (Y) ColorSetting value, nnn = 000 ~ 255
<i>CRBnnn</i>	Set the Blue (Cb) ColorSetting value, nnn = 000 ~ 255
<i>CRYnnn</i>	Set the Gray ColorSetting value, nnn = 000 ~ 255
<i>CRR999</i>	Query Red (Cr) ColorSetting status (see note 3 on page 81)
<i>CRG999</i>	Query Green (Y) ColorSetting status
<i>CRB999</i>	Query Blue (Cb) ColorSetting status
<i>CRY999</i>	Query Gray ColorSetting status
<i>CSC001</i>	Set color space to RGB:444
<i>CSC002</i>	Set color space to YUV:444
<i>CSC003</i>	Set color space to YUV:422
<i>CSC999</i>	Query color space status
<i>DEE001</i>	Set deep color to 8-bit
<i>DEE002</i>	Set deep color to 10-bit
<i>DEE003</i>	Set deep color to 12-bit
<i>DEE999</i>	Query deep color status
<i>ESC001</i>	EDID source is from Tx (HDMI / DVI Out)
<i>ESC002</i>	EDID source is from Rx (built-in active EDID)
<i>ESC003</i>	EDID source is from Rx1 (built-in EDID1)
<i>ESC004</i>	EDID source is from Rx2 (built-in EDID2)

## RS-232 COMMANDS

Command	Description
<i>ESC005</i>	EDID source is from Rx3 (built-in EDID3)
<i>ESC006</i>	EDID source is from VGA (PC / HD out)
<i>ERD001</i>	Read EDID from sink (see note 4 on page 81)
<i>ERS001</i>	Erase sink's EDID and fill all bytes with FF (see note 5 on page 81)
<i>EWR001</i>	Write EDID to sink (see note 6 on page 81)
<i>FAV000</i>	Set My Favorite OFF
<i>FAV001</i>	Set My Favorite ON
<i>FAV999</i>	Query My Favorite action status
<i>FP+nnn</i>	Add Pattern to Favorites, nnn = 001 ~ 050
<i>FP-nnn</i>	Drop Pattern from Favorites, nnn = 001 ~ 050
<i>FP+999</i>	Query Favorite Pattern status ( <i>FP-999</i> can also be used)
<i>FT+nnn</i>	Add Timing to Favorites, nnn = 001 ~ 039
<i>FT-nnn</i>	Drop Timing from Favorites, nnn = 001 ~ 039
<i>FT+999</i>	Query Favorite Timing status ( <i>FT-999</i> can also be used)
<i>HDC000</i>	Set HDCP OFF
<i>HDC001</i>	Set HDCP ON
<i>HDC999</i>	Query HDCP status
<i>MOT001</i>	Set custom string for Pattern 46 (see note 7 on page 81)
<i>MOT999</i>	Query string from Pattern 46
<i>OUT001</i>	Select output format [PC]
<i>OUT002</i>	Select output format [HD]
<i>OUT003</i>	Select output format [DVI]
<i>OUT004</i>	Select output format [HDMI]
<i>OUT999</i>	Query output format status
<i>PATnnn</i>	Select Pattern, nnn = 001 ~ 050
<i>PAT999</i>	Query Pattern status
<i>PCM001</i>	Set PCM 2CH
<i>PCM002</i>	Set PCM 5.1CH
<i>PCM003</i>	Set PCM 7.1CH
<i>PCM999</i>	Query PCM status
<i>RST001</i>	Reset Signal Generator
<i>TIMnnn</i>	Select Timing, nnn = 001 ~ 039
<i>TIM999</i>	Query Timing status
<i>VER999</i>	Query firmware version

### Notes

1. After the RS-232 device sends commands to the HD Pattern Signal Generator, the RS-232 device must wait for the HD Pattern Signal Generator to respond. Although the RS-232 device can send another command without waiting for a response, the communication may fail if the HD Pattern Signal Generator is in Auto mode.
2. To configure the HD Pattern Signal Generator to follow a sequence of commands in Auto mode, the following syntax is used: `ATNxxx + ATTxxx + ATPxxx + ATLxxx...`
3. If the HD Pattern Signal Generator is not set to Pattern 47, running a query for the ColorSetting pattern will return: `CRR300`, `CRG300`, `CRB300` or `CRY300`.
4. After sending the `ERD001` response, the HD Pattern Signal Generator reads the sink's EDID and transmits the data to the remote terminal. If the EDID cannot be read, then the HD Pattern Signal Generator sends `0xFE` and stops the datastream. The HD Pattern Signal Generator supports a 256-byte EDID (block0 + block1).
5. After sending the `ERS001` response, the HD Pattern Signal Generator erases the sink's EDID and fills all bytes with `FF`. After the EDID is erased, the HD Pattern Signal Generator returns `ERS002`. If the process fails, then `ERS003` is returned.
6. After sending the `EWR001` response, the HD Pattern Signal Generator waits for the EDID datastream (256 bytes) from the RS-232 device. After receiving the datastream, the HD Pattern Signal Generator writes the EDID to the sink. If the write-process is successful, then `EWR002` is returned. If the write-process fails, then `EWR003` is returned.
7. Send `MOT001` and wait for the `MOT001` response from the HD Pattern Signal Generator. Send the custom string and wait for the `MOT002` response. The maximum length for a string is 12 bytes. Any unused bytes must be filled with `0x00`. Only English characters are supported.

# WALL MOUNTING INSTRUCTIONS

---

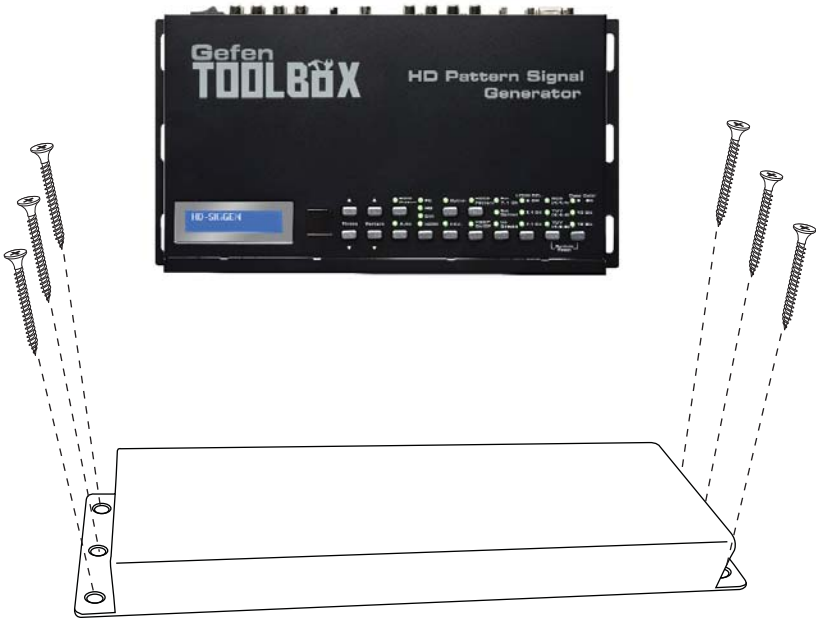

The GefenToolBox HD Pattern Signal Generator should be mounted vertically in a wall or cabinet with wood/drywall screws as shown in the diagram above. There should be an inch or two of clearance between the edges of the unit and any walls or vertical surfaces to allow for enough clearance for insertion and removal of cables on the back of the unit.

For installation on a drywall surface, use a #6 drywall screw. It is recommended when installing on a drywall surface that studs be used to secure the Splitter should undue stress be applied when connecting and disconnecting HDMI cables.



## SPECIFICATIONS

---

Maximum Pixel Clock.....	165 MHz
Input Video Signal .....	1.2V p-p
Input DDC Signal .....	5V p-p (TTL)
Video Input.....	(1) HDMI Type A , 19-pin, female
Video Output.....	(1) HDMI, Type A, 19-pin, female
Video Output.....	(1) HD15, female
Analog Audio Inputs.....	FL, FR, C, LFE, SL, SR, SSL, SSR (RCA type)
Analog Audio Outputs.....	FL, FR, C, LFE, SL, SR, SSL, SSR (RCA type)
Digital Audio Input.....	(1) TosLink
Digital Audio Outputs.....	(1) TosLink, (1) S/PDIF
Input Impedance.....	10 k $\Omega$
Frequency Response.....	20 Hz - 20 kHz ( $\pm$ 0.5 dB)
SNR.....	> 90 dB
THD.....	< 0.001% at 1 kHz or 2 V rms
Crosstalk.....	> 90 dB
RS-232 Serial Port.....	DB-9, female
Power Supply .....	5V DC
Power Consumption .....	10W (max.)
Operating Temperature .....	0 - 40 $^{\circ}$ C
Dimensions .....	12.0" W x 1.75" H x 6.5" D
Shipping Weight .....	6 lbs.

## WARRANTY

---

Gefen warrants the equipment it manufactures to be free from defects in material and workmanship.

If equipment fails because of such defects and Gefen is notified within two (2) years from the date of shipment, Gefen will, at its option, repair or replace the equipment, provided that the equipment has not been subjected to mechanical, electrical, or other abuse or modifications. Equipment that fails under conditions other than those covered will be repaired at the current price of parts and labor in effect at the time of repair. Such repairs are warranted for ninety (90) days from the day of reshipment to the Buyer.

This warranty is in lieu of all other warranties expressed or implied, including without limitation, any implied warranty or merchantability or fitness for any particular purpose, all of which are expressly disclaimed.

1. Proof of sale may be required in order to claim warranty.
2. Customers outside the US are responsible for shipping charges to and from Gefen.
3. Copper cables are limited to a 30 day warranty and cables must be in their original condition.

The information in this manual has been carefully checked and is believed to be accurate. However, Gefen assumes no responsibility for any inaccuracies that may be contained in this manual. In no event will Gefen be liable for direct, indirect, special, incidental, or consequential damages resulting from any defect or omission in this manual, even if advised of the possibility of such damages. The technical information contained herein regarding the features and specifications is subject to change without notice.

For the latest warranty coverage information, refer to the Warranty and Return Policy under the Support section of the Gefen Web site at [www.gefen.com](http://www.gefen.com).

## PRODUCT REGISTRATION

**Please register your product online by visiting the Register Product page under the Support section of the Gefen Web site.**





**20600 Nordhoff St., Chatsworth CA 91311**  
**1-800-545-6900 818-772-9100 fax: 818-772-9120**  
**[www.gefentoolbox.com](http://www.gefentoolbox.com) [support@gefentoolbox.com](mailto:support@gefentoolbox.com)**



This product uses UL or CE listed power supplies.